

Seq	1		
Scene	Duration	Panel	Duration
1	01:00	1	00:08

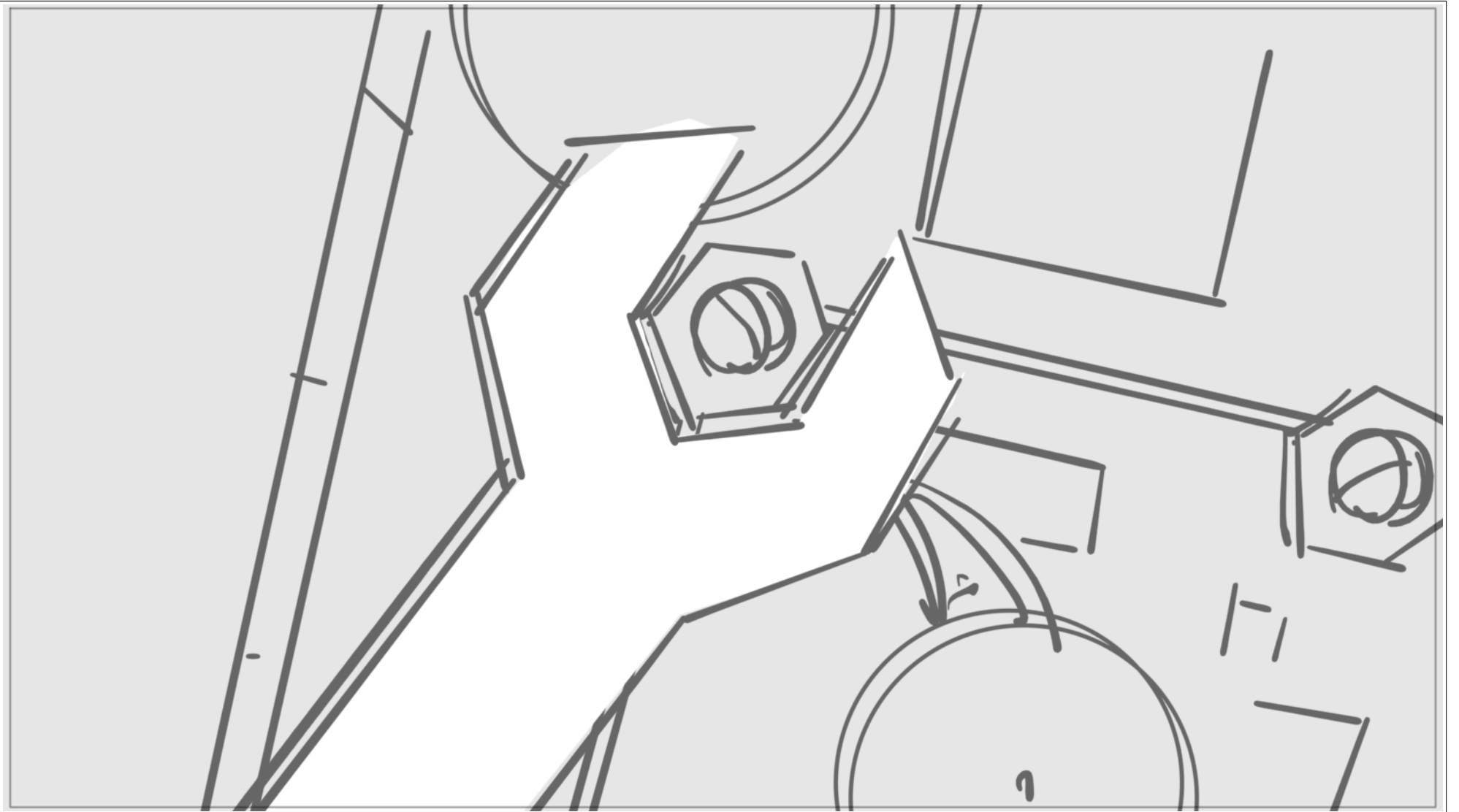

Seq	1		
Scene	Duration	Panel	Duration
1	01:00	2	00:16

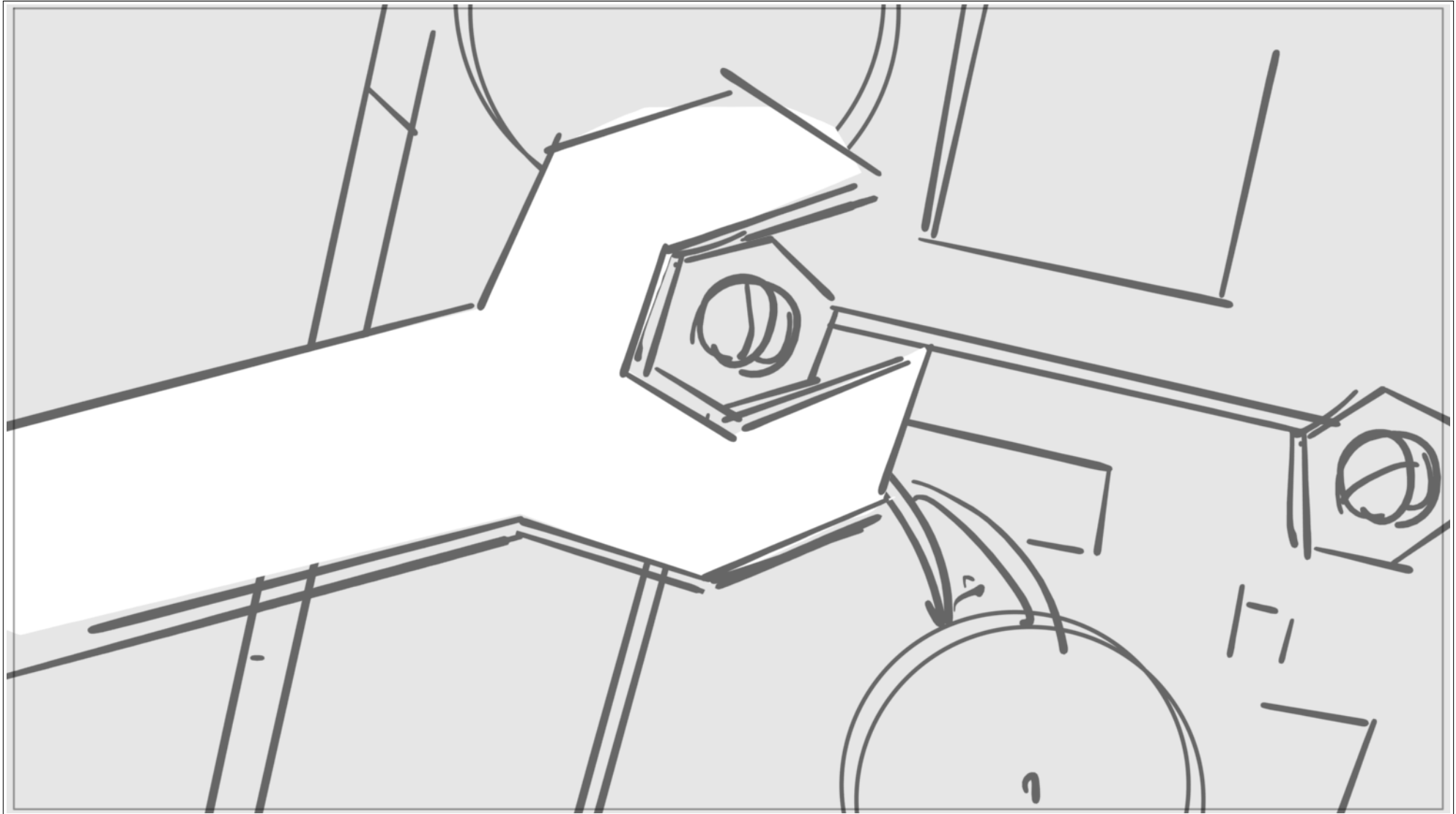

Seq	1		
Scene	Duration	Panel	Duration
2	00:22	1	00:06

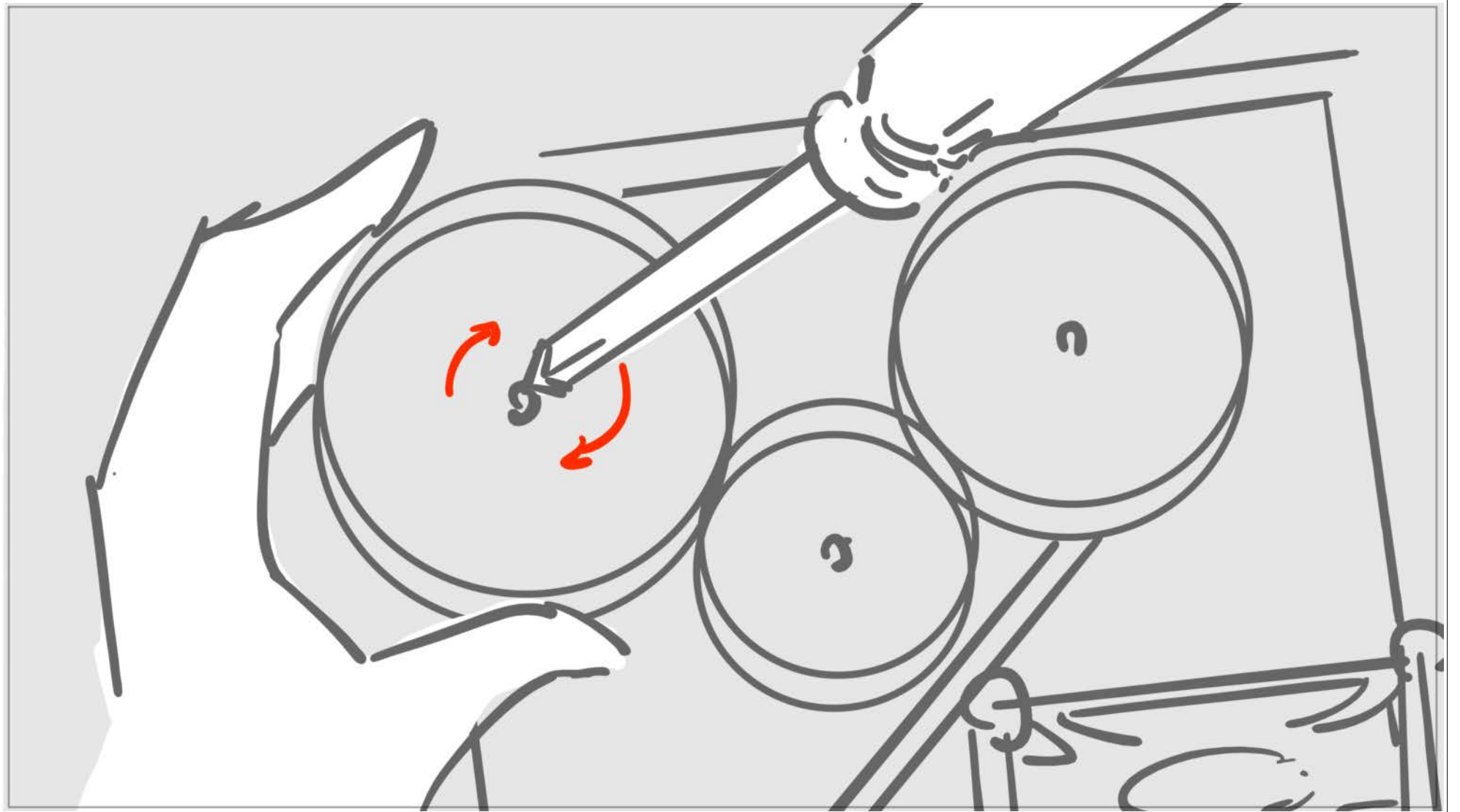

Seq	1		
Scene	Duration	Panel	Duration
2	00:22	2	00:16

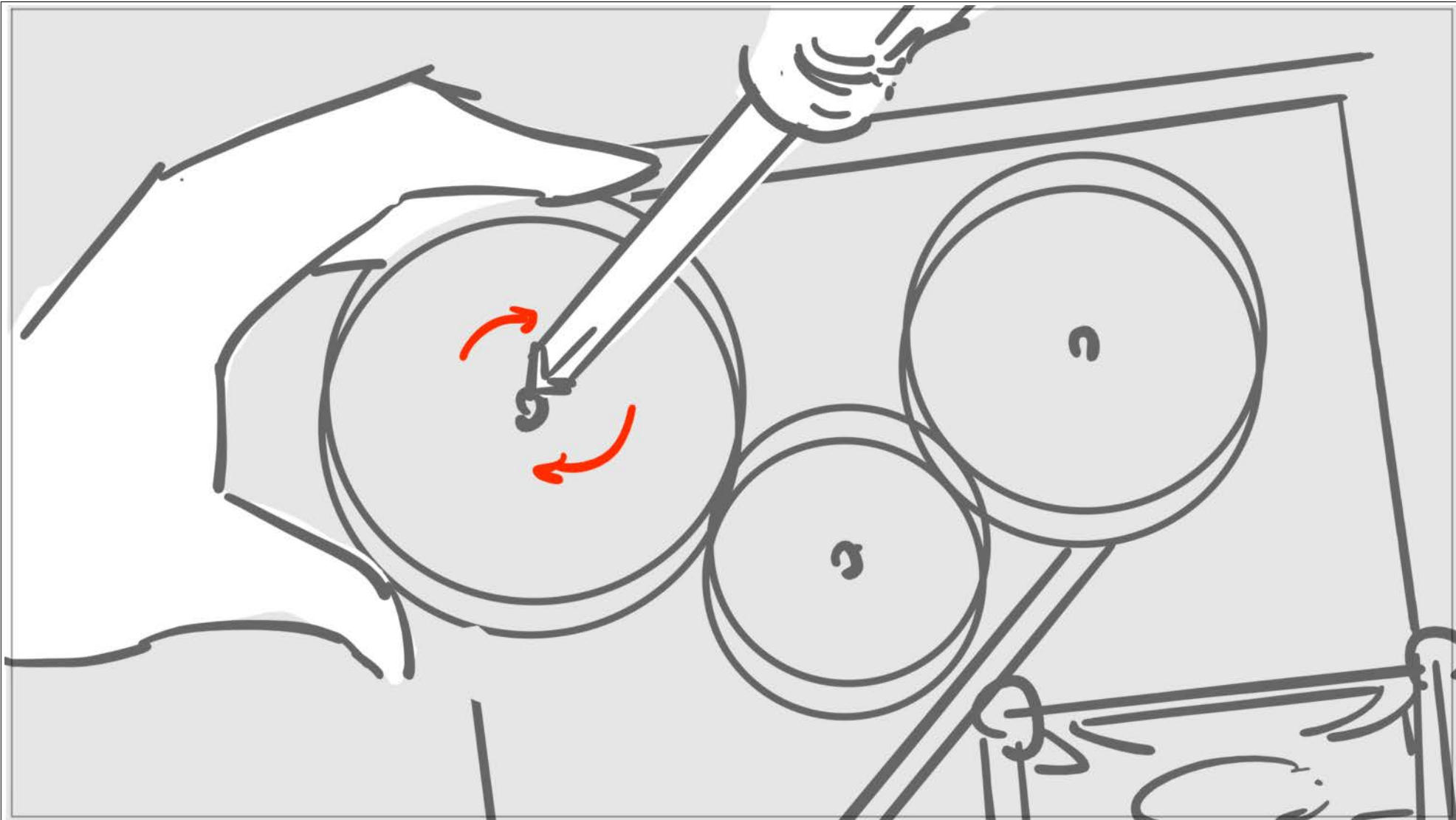

Seq	1		
Scene	Duration	Panel	Duration
3	01:00	1	01:00

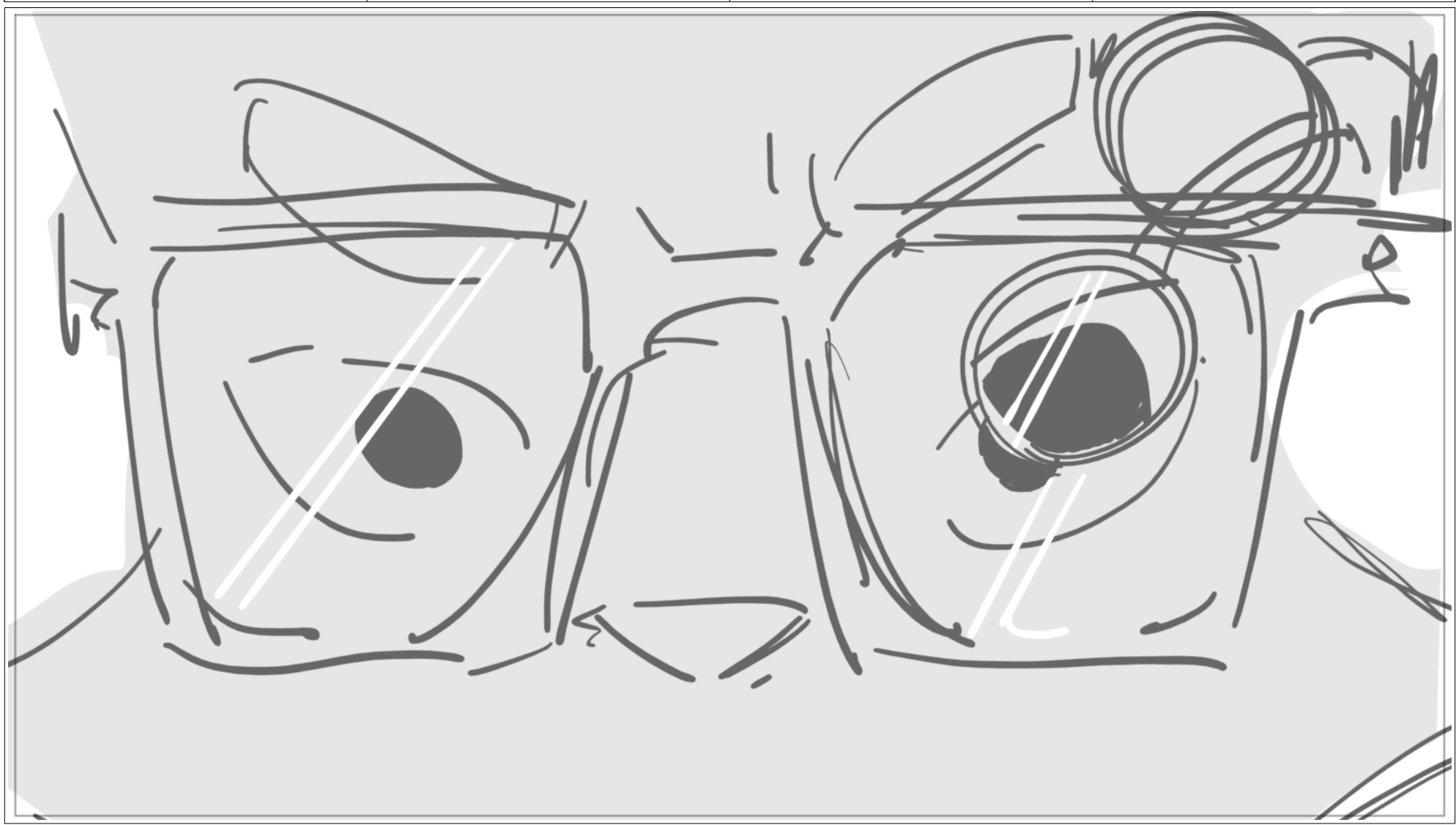

Seq	1		
Scene	Duration	Panel	Duration
4	01:06	1	00:08

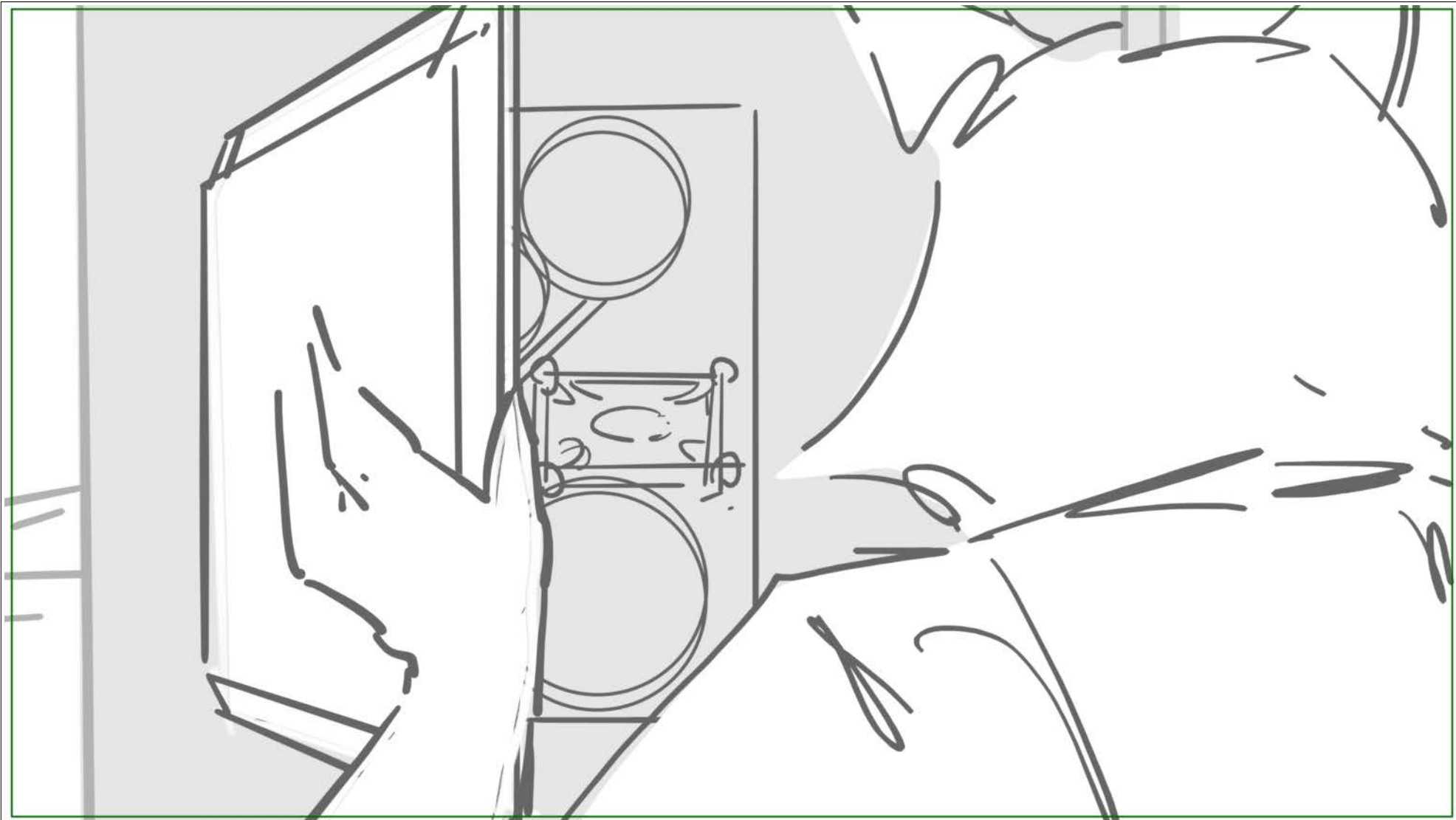

Seq	1		
Scene	Duration	Panel	Duration
4	01:06	2	00:14



Seq	1		
Scene	Duration	Panel	Duration
4	01:06	3	00:08

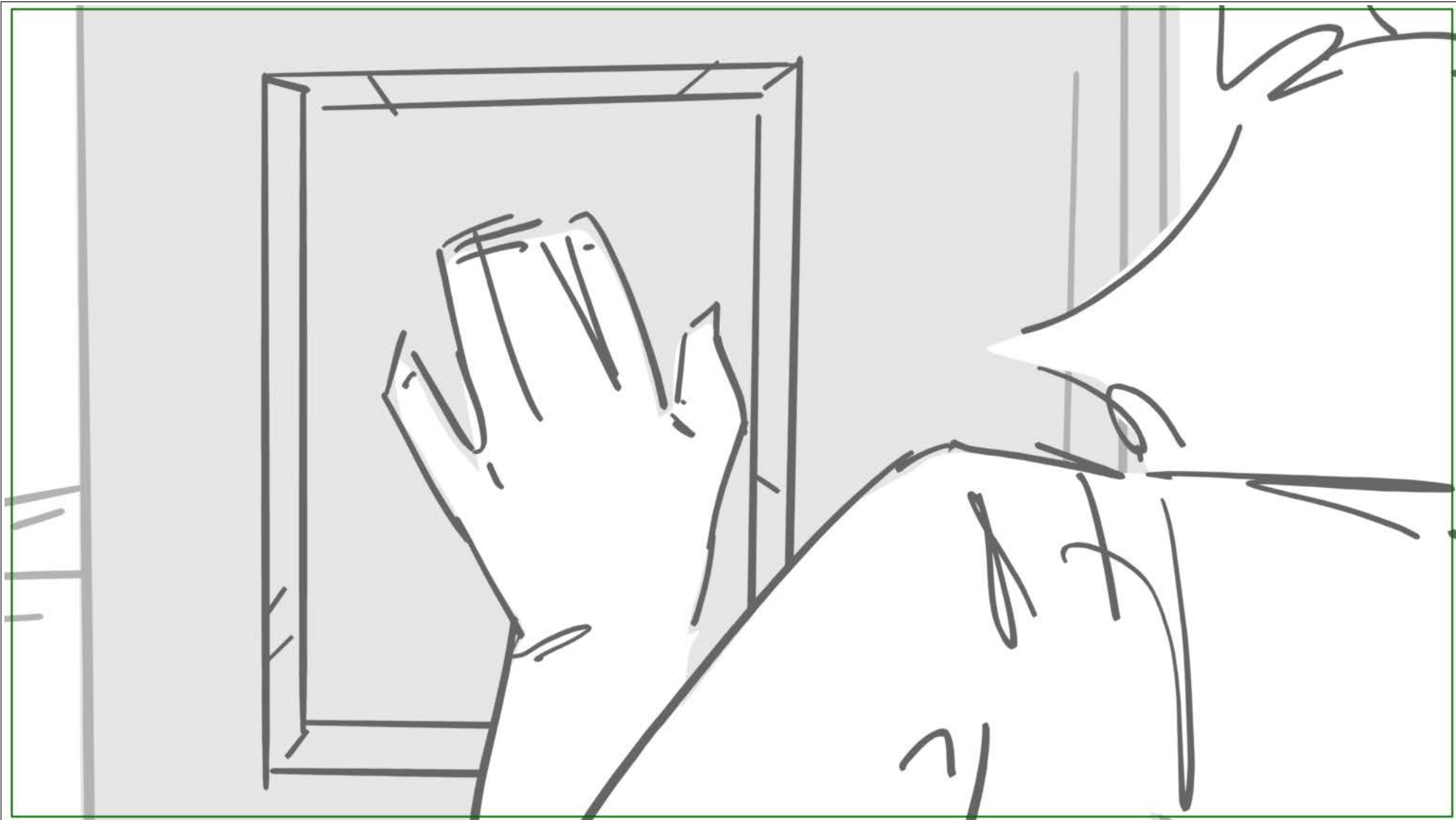

Blank area for dialogue or notes.

Seq	1		
Scene	Duration	Panel	Duration
5	00:15	1	00:03



Seq	1		
Scene	Duration	Panel	Duration
5	00:15	2	00:03



Seq	1		
Scene	Duration	Panel	Duration
5	00:15	3	00:03



Seq	1		
Scene	Duration	Panel	Duration
5	00:15	4	00:03



Seq	1		
Scene	Duration	Panel	Duration
5	00:15	5	00:03



Seq	1		
Scene	Duration	Panel	Duration
5a	01:08	1	01:08

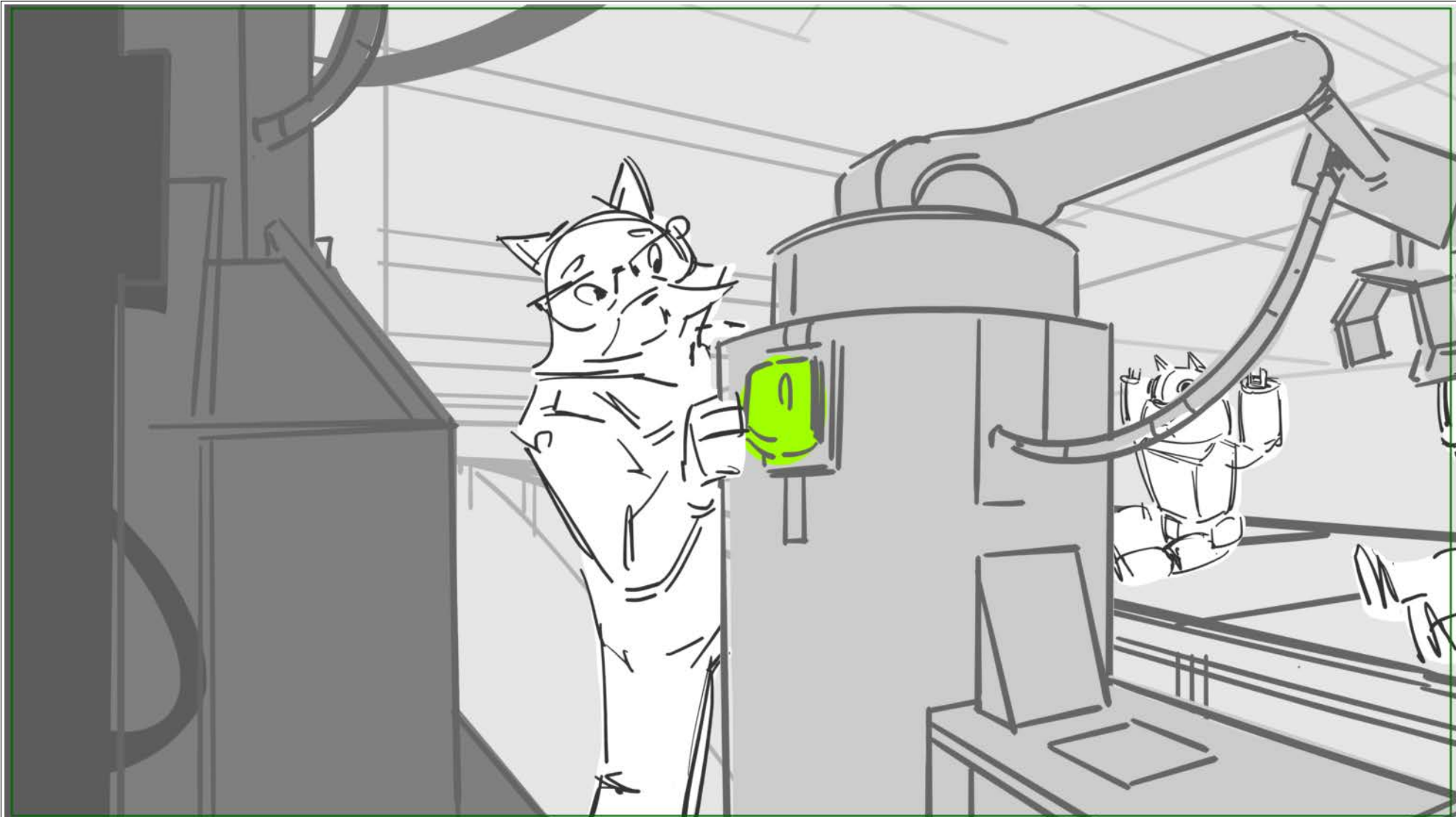

Seq	1		
Scene	Duration	Panel	Duration
5b	01:03	1	01:03

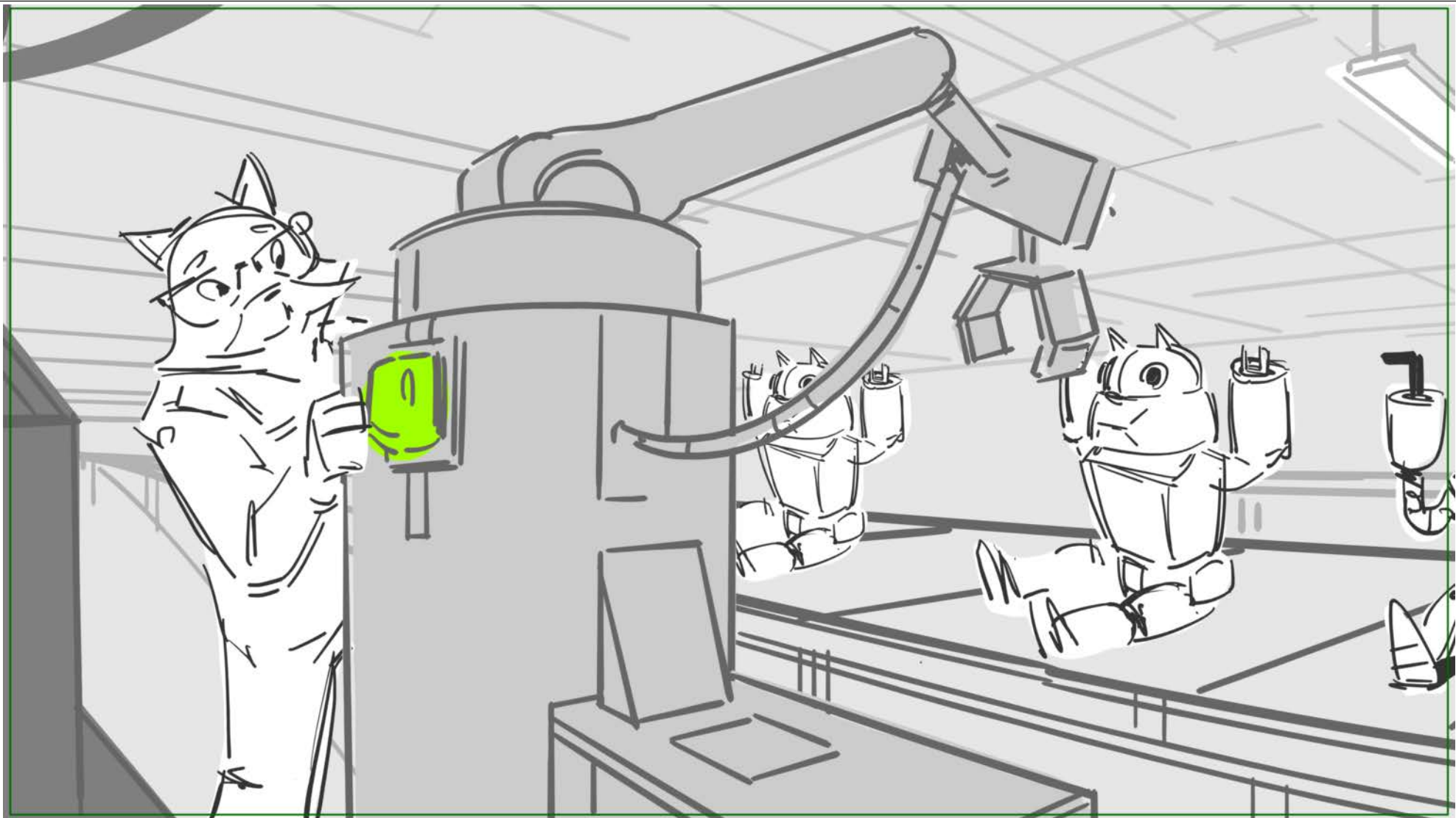

Seq	1		
Scene	Duration	Panel	Duration
5c	01:08	1	01:08

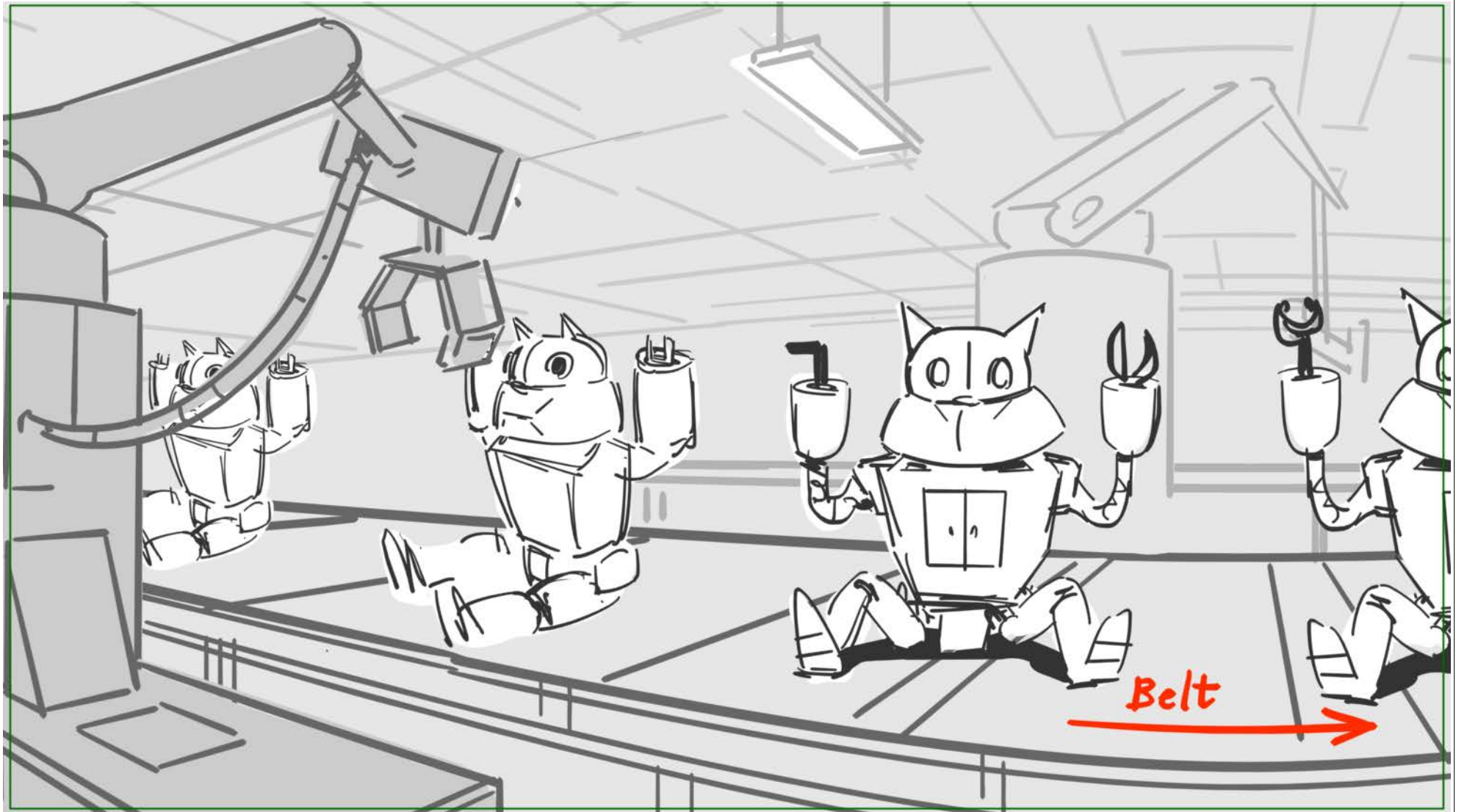

Seq	1		
Scene	Duration	Panel	Duration
5d	01:05	1	01:05

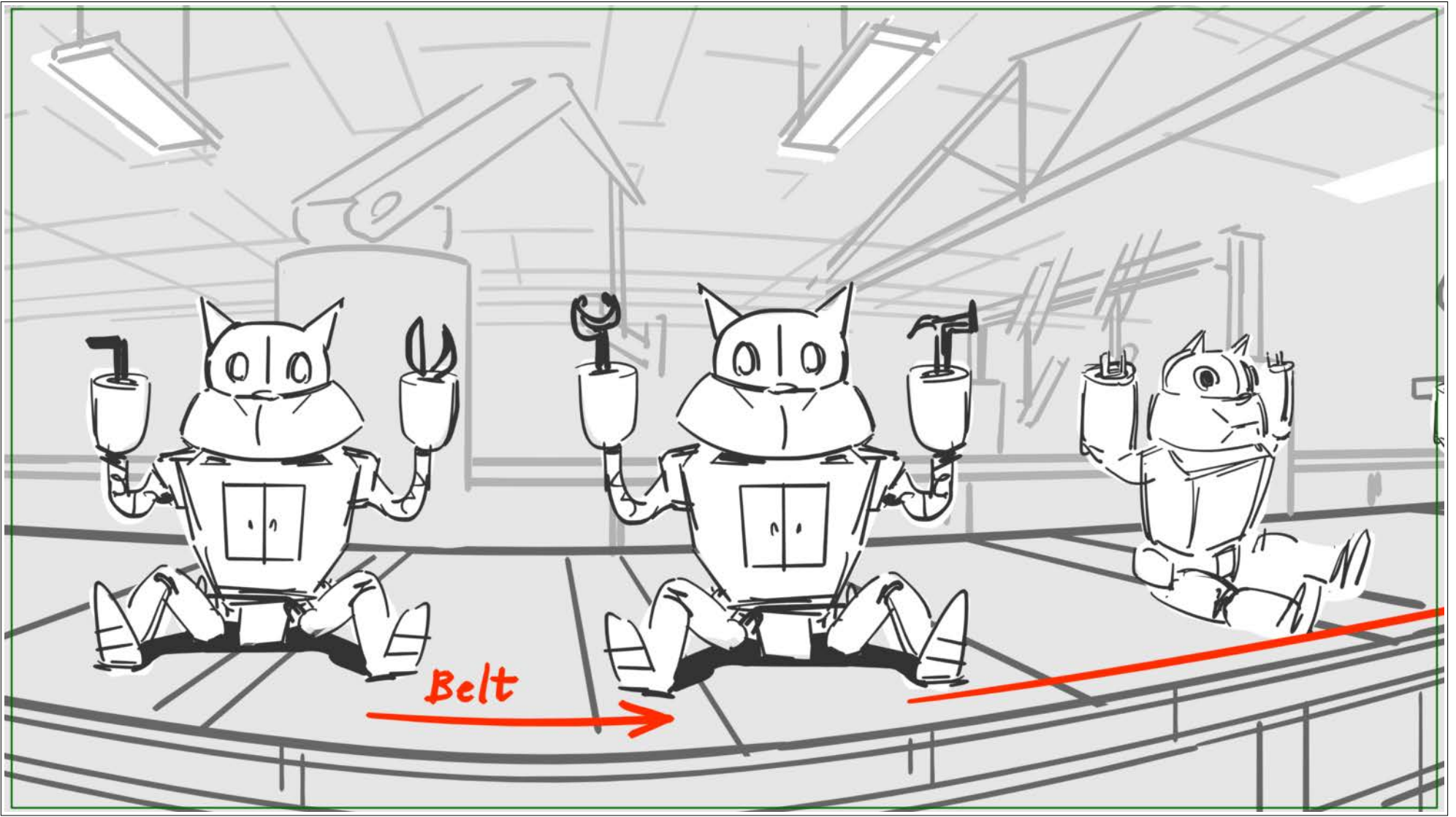

Seq	1		
Scene	Duration	Panel	Duration
5e	01:15	1	01:15

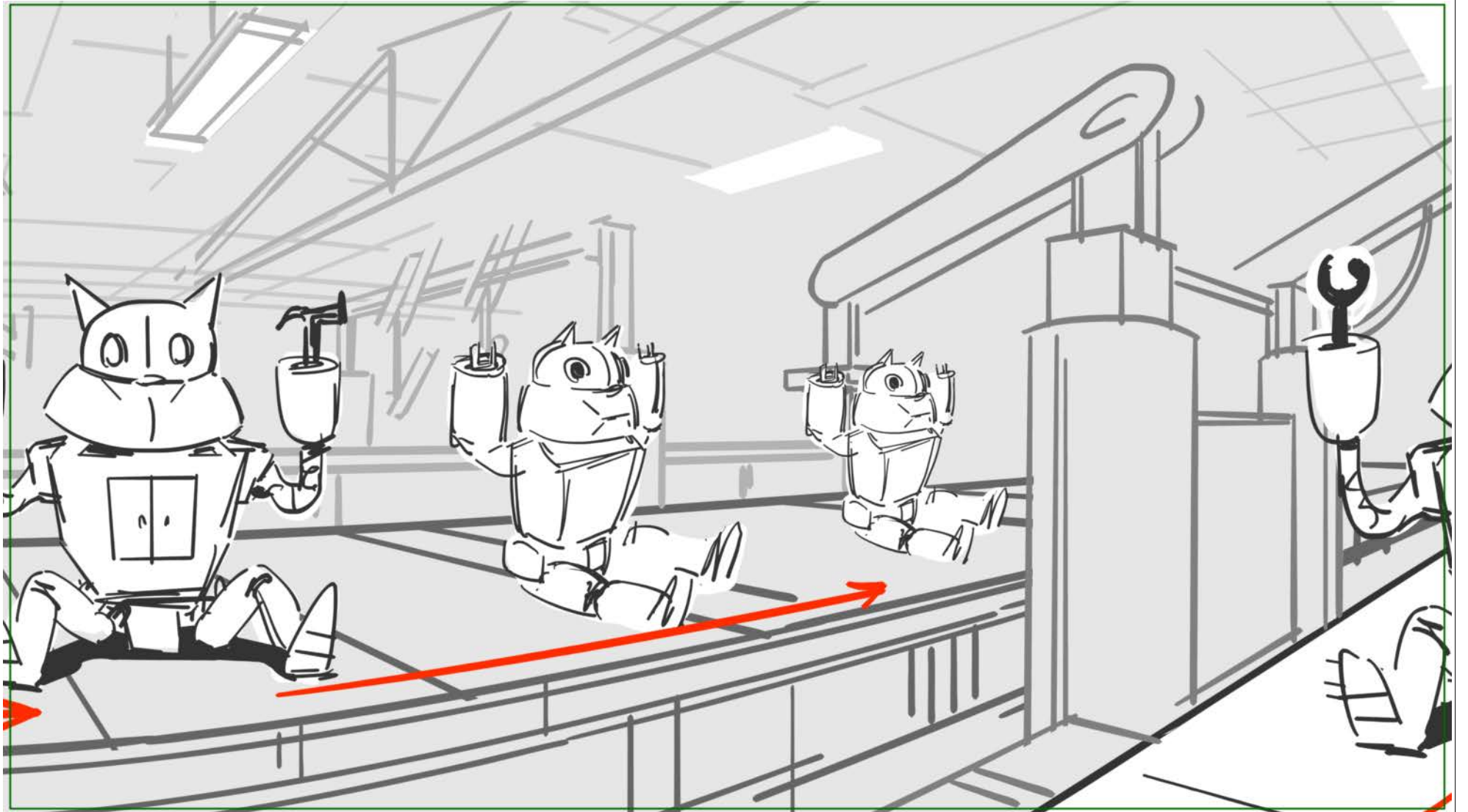

Seq	1		
Scene	Duration	Panel	Duration
5f	00:22	1	00:22

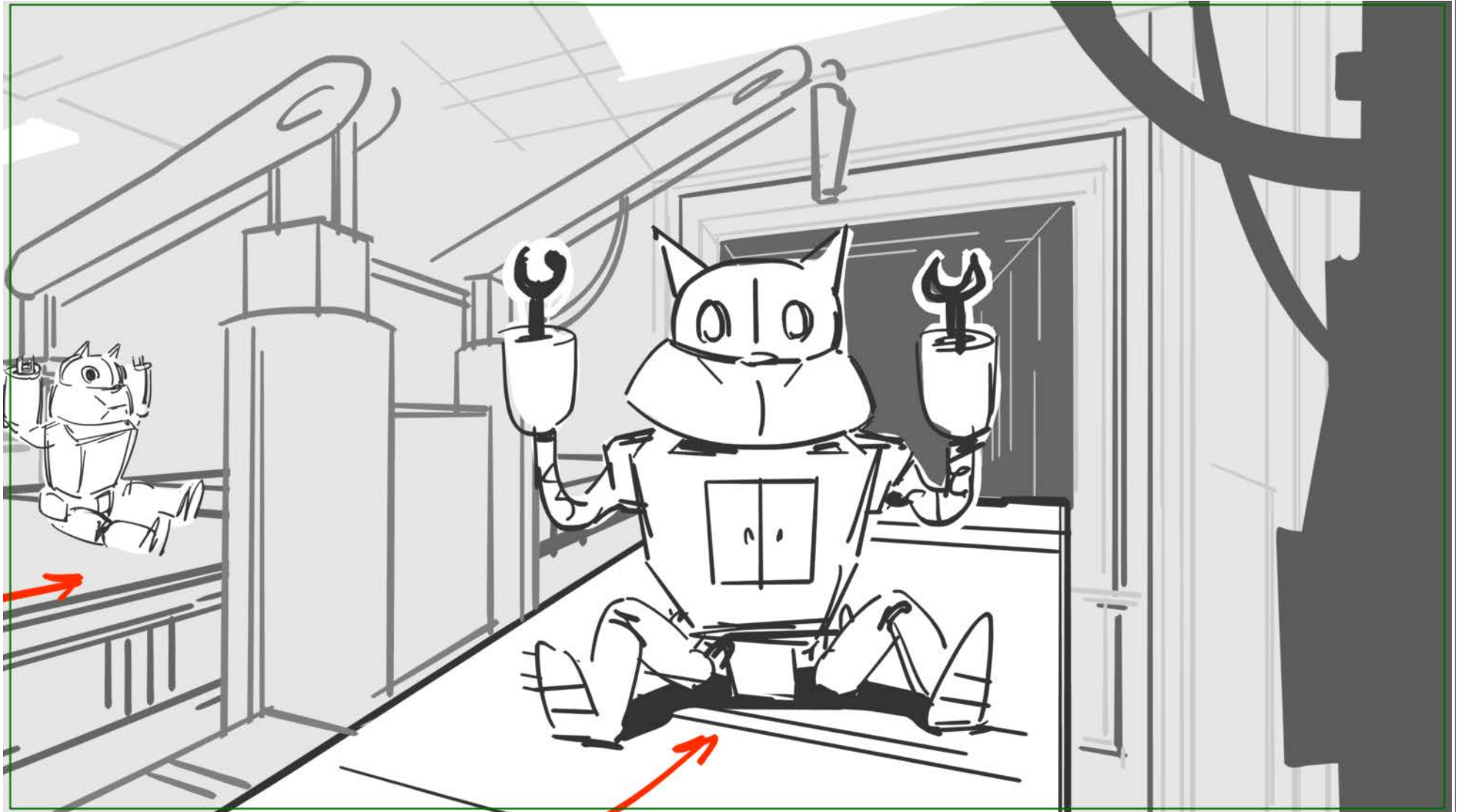

Seq	1		
Scene	Duration	Panel	Duration
6	00:18	1	00:18



Seq	1		
Scene	Duration	Panel	Duration
6A	00:17	1	00:17



Seq	1		
Scene	Duration	Panel	Duration
6AA	02:14	1	00:08

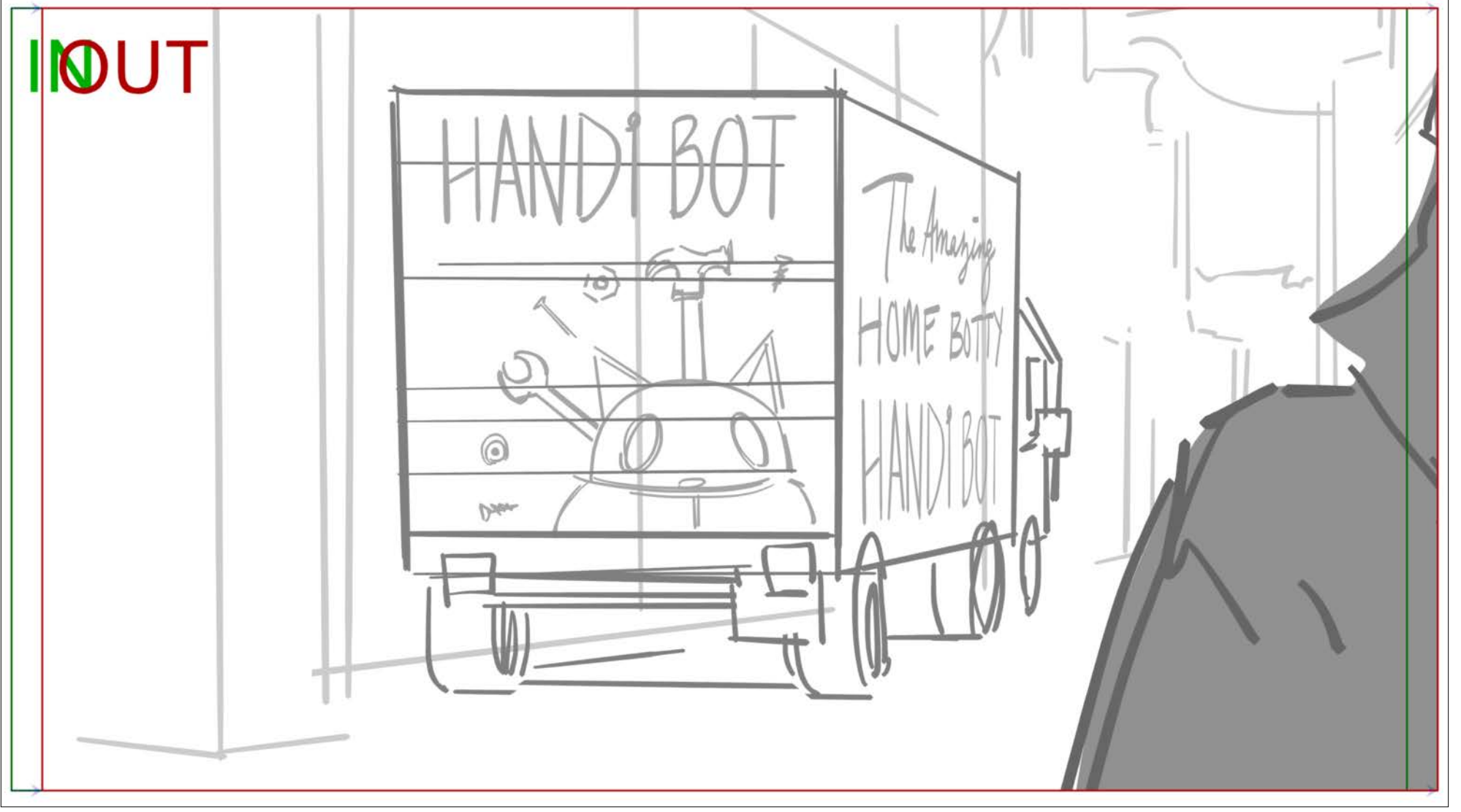

Seq	1		
Scene	Duration	Panel	Duration
6AA	02:14	2	00:05

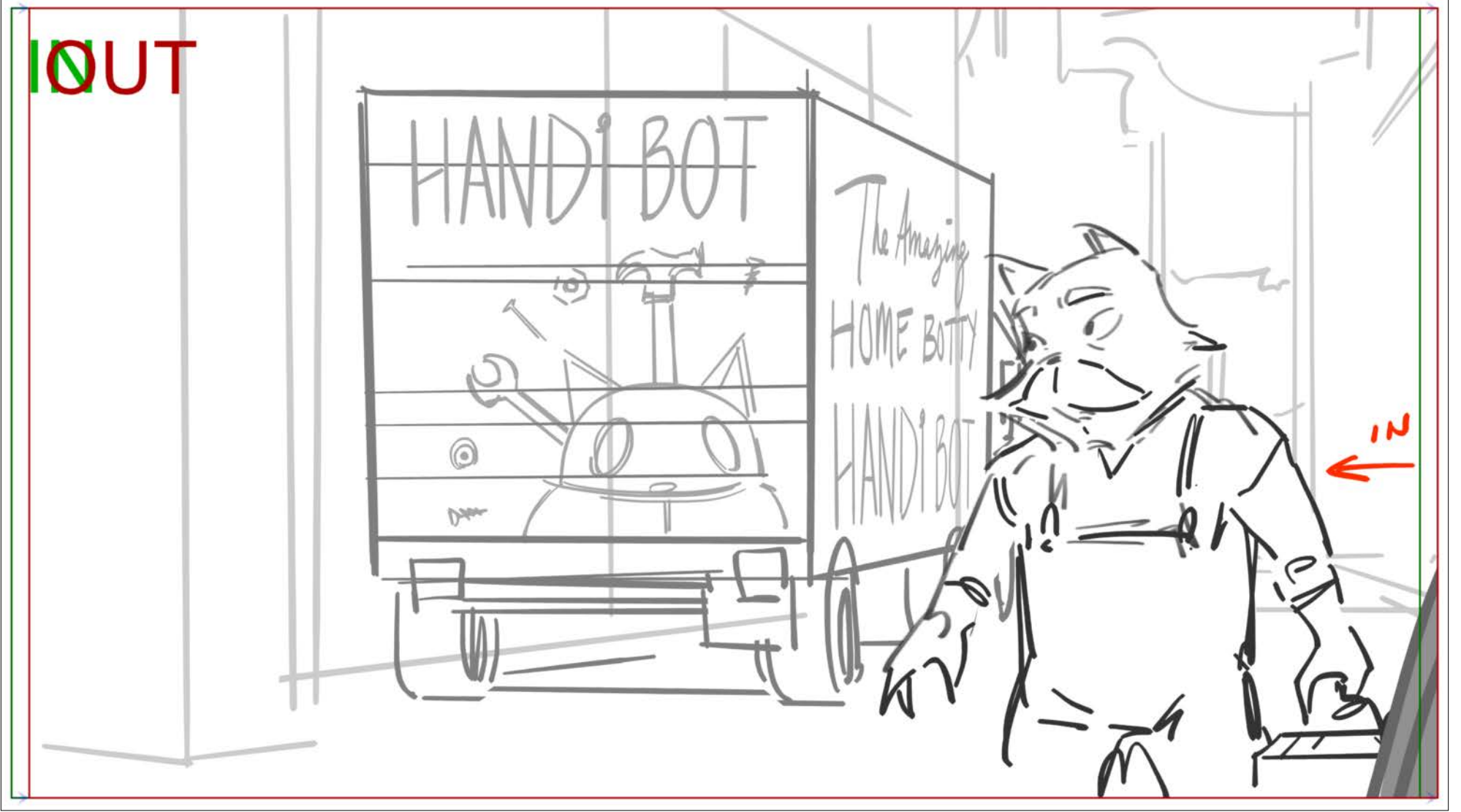

Seq	1		
Scene	Duration	Panel	Duration
6AA	02:14	3	00:08

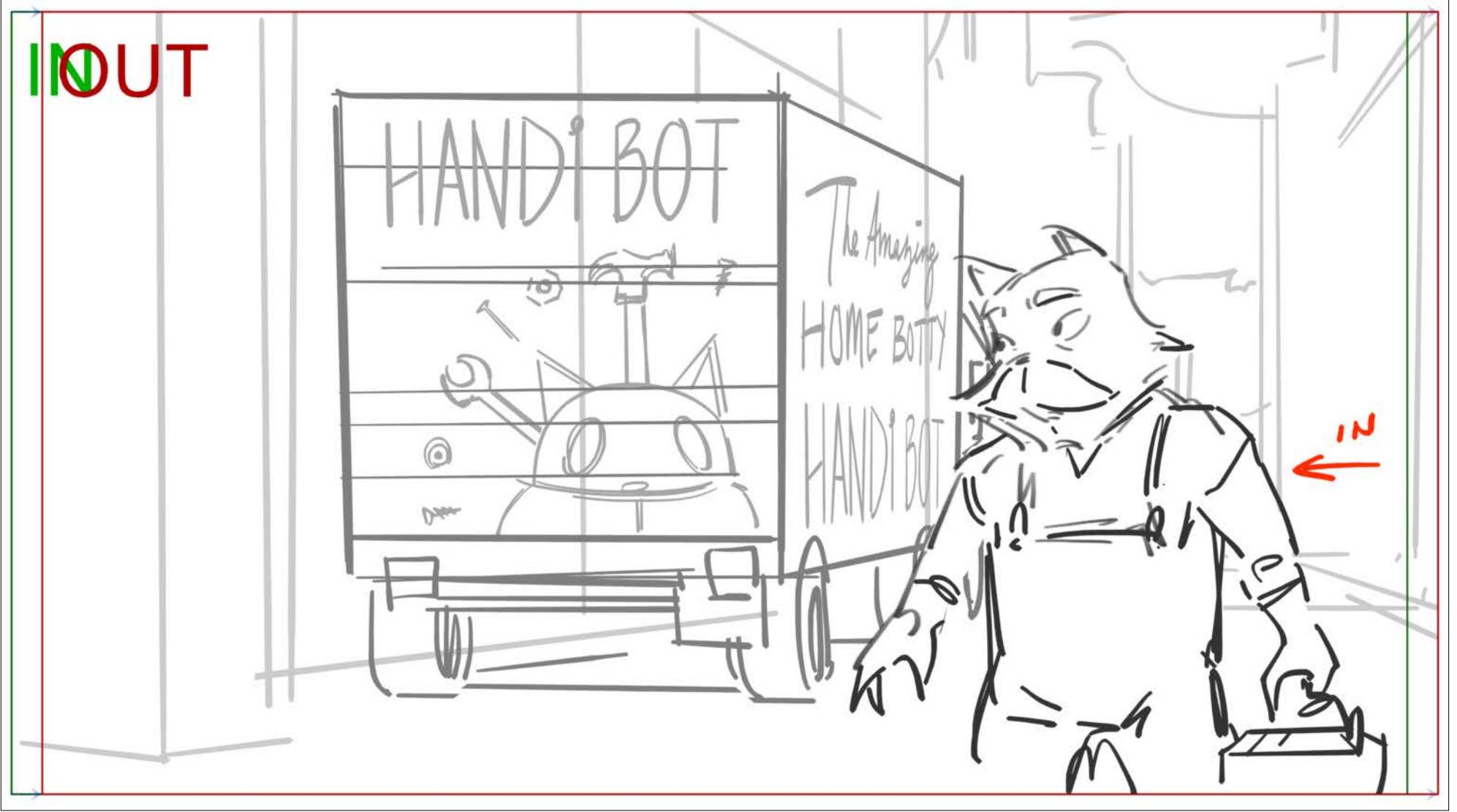

Seq	1		
Scene	Duration	Panel	Duration
6AA	02:14	4	00:11

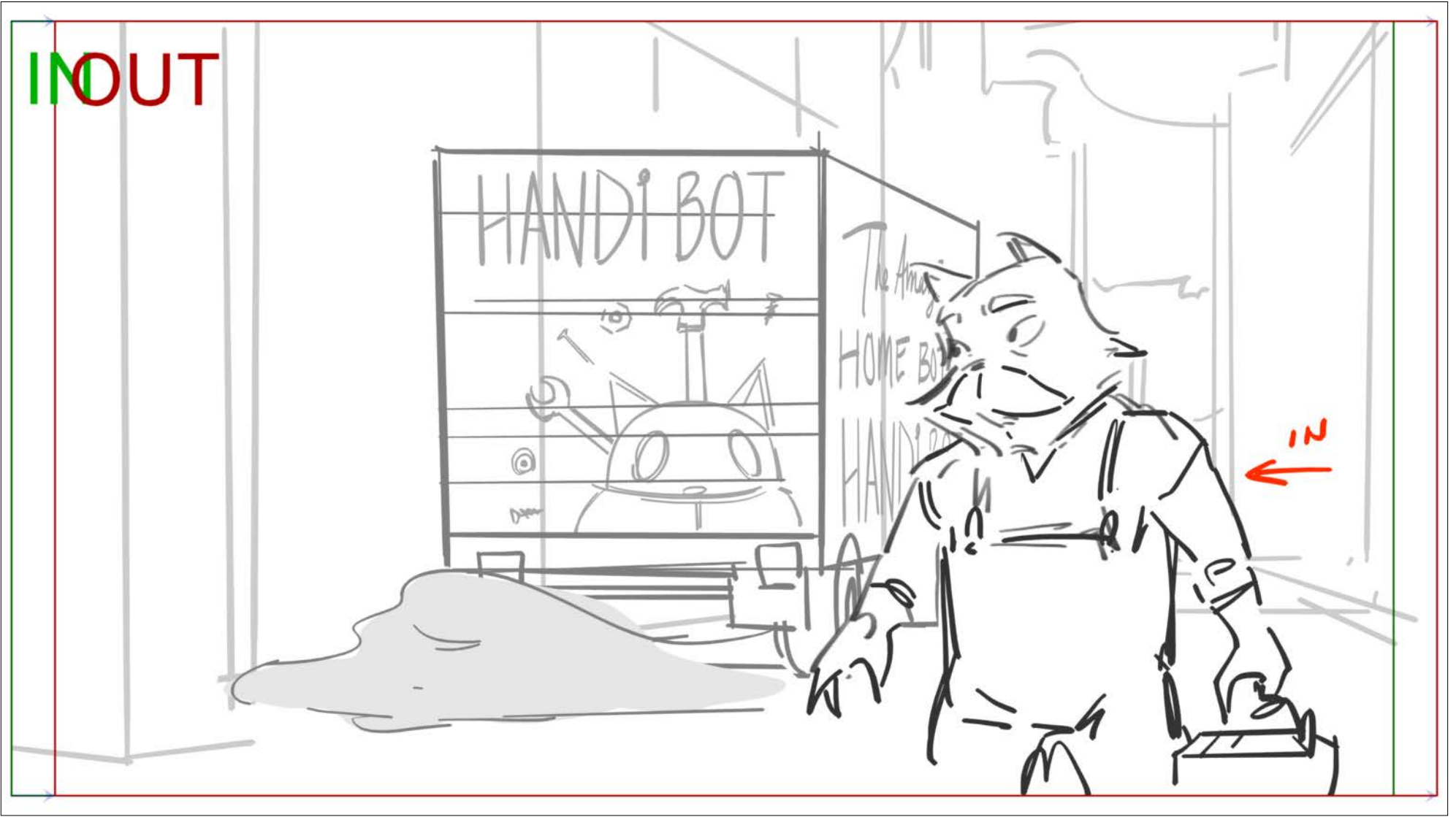

Seq	1		
Scene	Duration	Panel	Duration
6AA	02:14	5	00:18



Seq	1		
Scene	Duration	Panel	Duration
6AA	02:14	6	00:12



Seq	1						
Scene	7	Duration	02:22	Panel	1	Duration	01:12

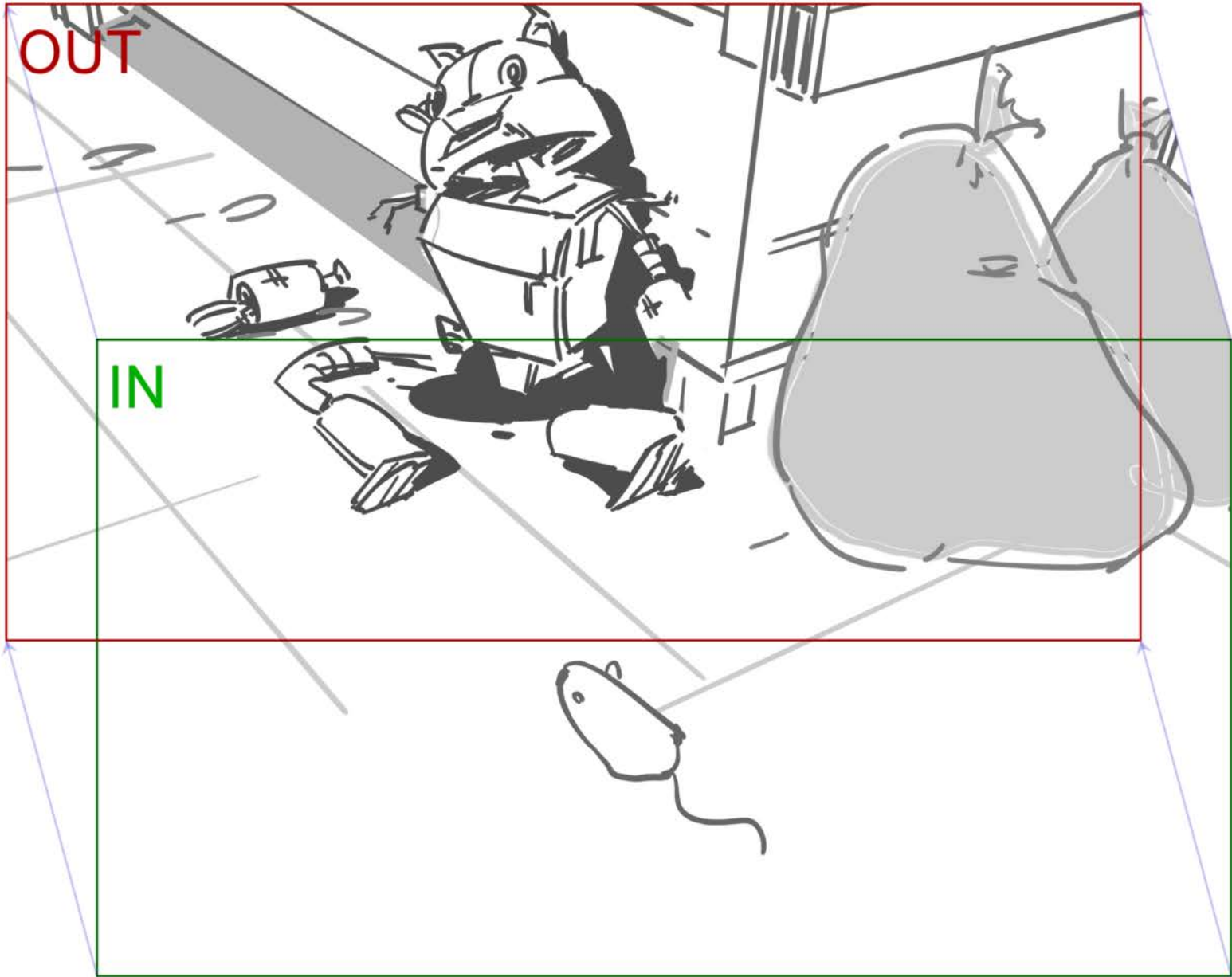

Seq	1		
Scene	Duration	Panel	Duration
7	02:22	2	00:06

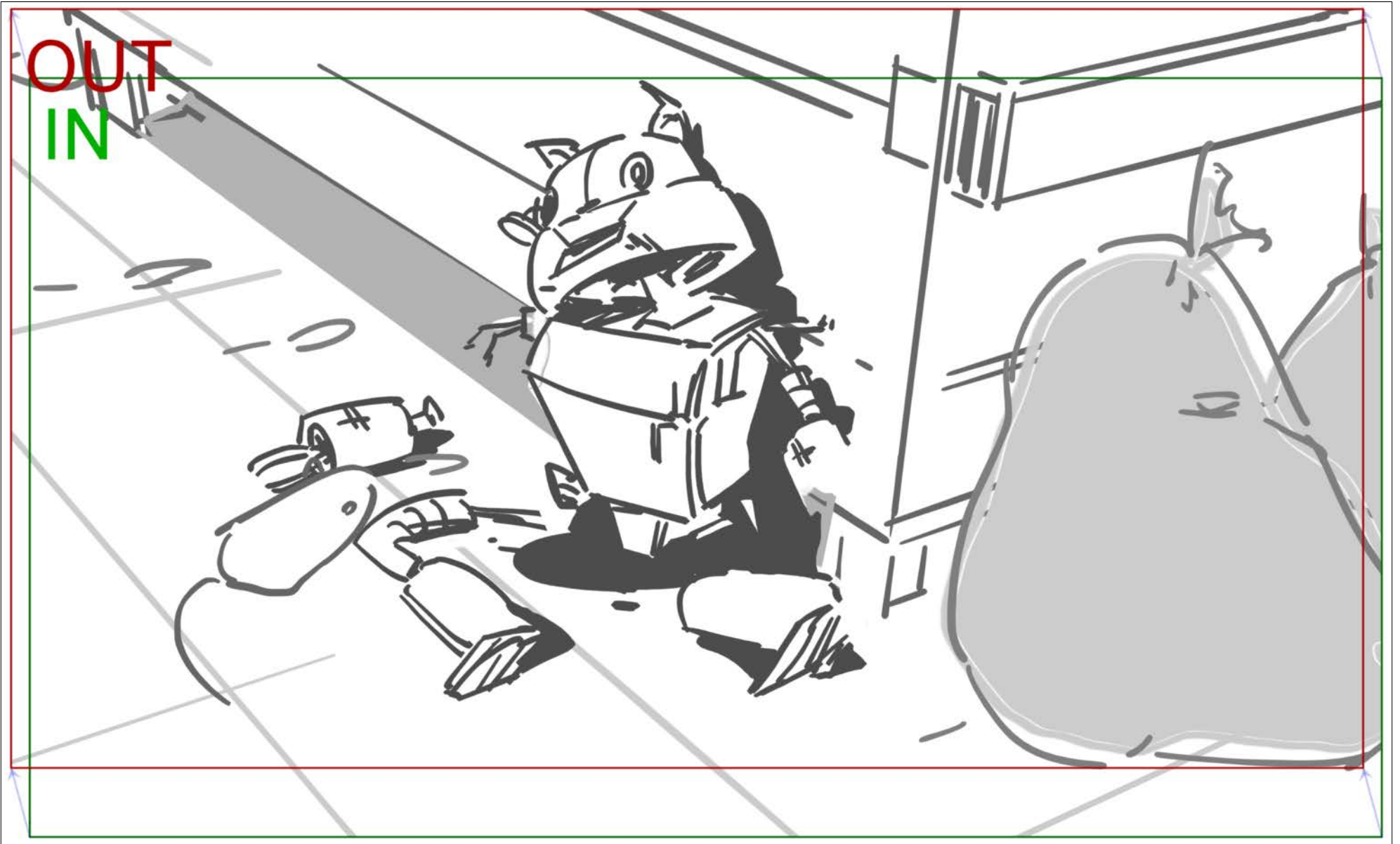

Seq	1		
Scene	Duration	Panel	Duration
7	02:22	3	00:07



Seq	1		
Scene	Duration	Panel	Duration
7	02:22	4	00:21



Seq	1		
Scene	Duration	Panel	Duration
8	01:13	1	00:06



Seq	1		
Scene	Duration	Panel	Duration
8	01:13	2	00:19



Seq	1		
Scene	Duration	Panel	Duration
8	01:13	3	00:06



Seq	1		
Scene	Duration	Panel	Duration
8	01:13	4	00:06

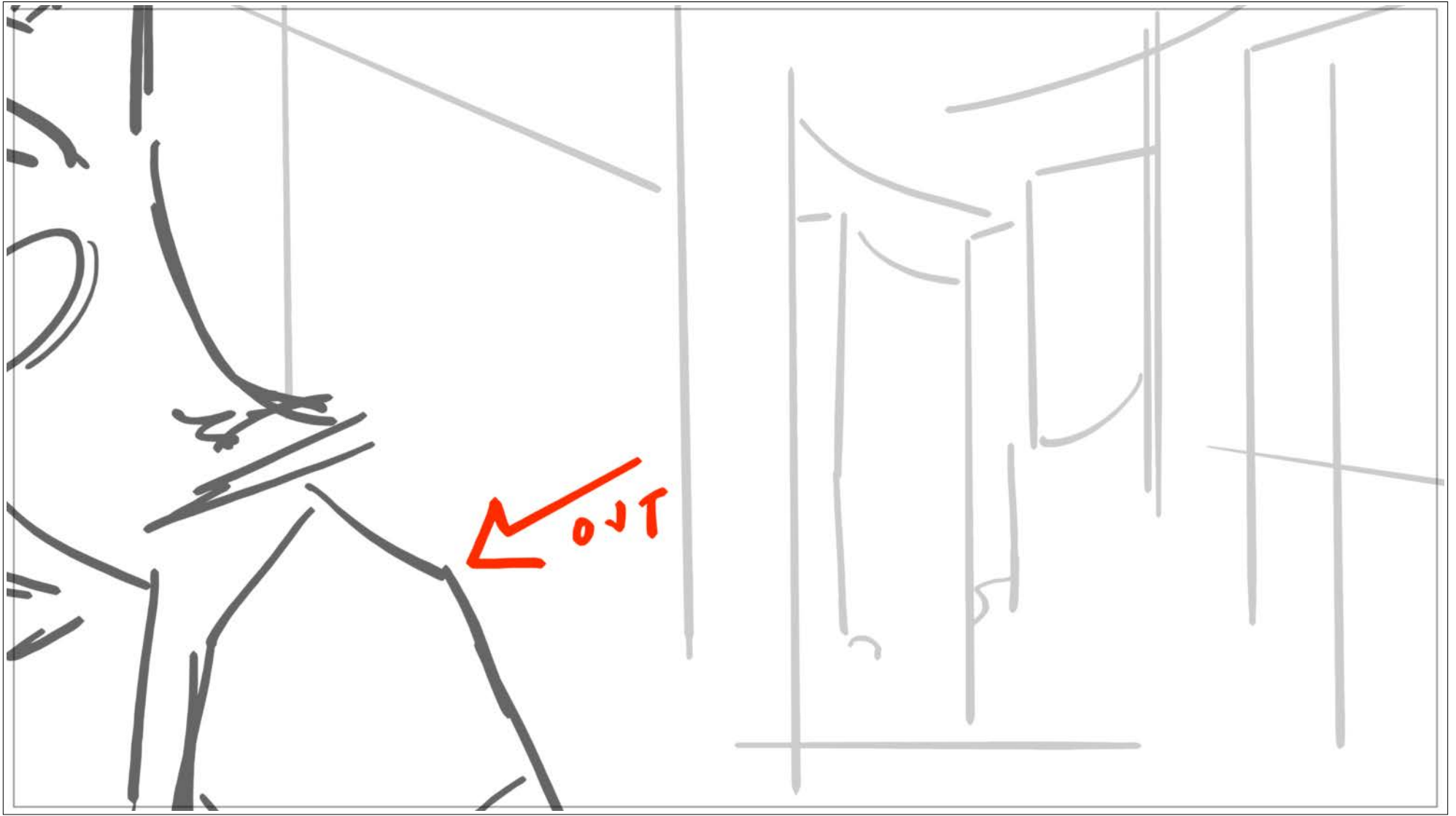

Seq	1		
Scene	Duration	Panel	Duration
9	02:05	1	00:12



Seq	1		
Scene	Duration	Panel	Duration
9	02:05	2	00:05



Seq	1		
Scene	Duration	Panel	Duration
9	02:05	3	00:12

Dia

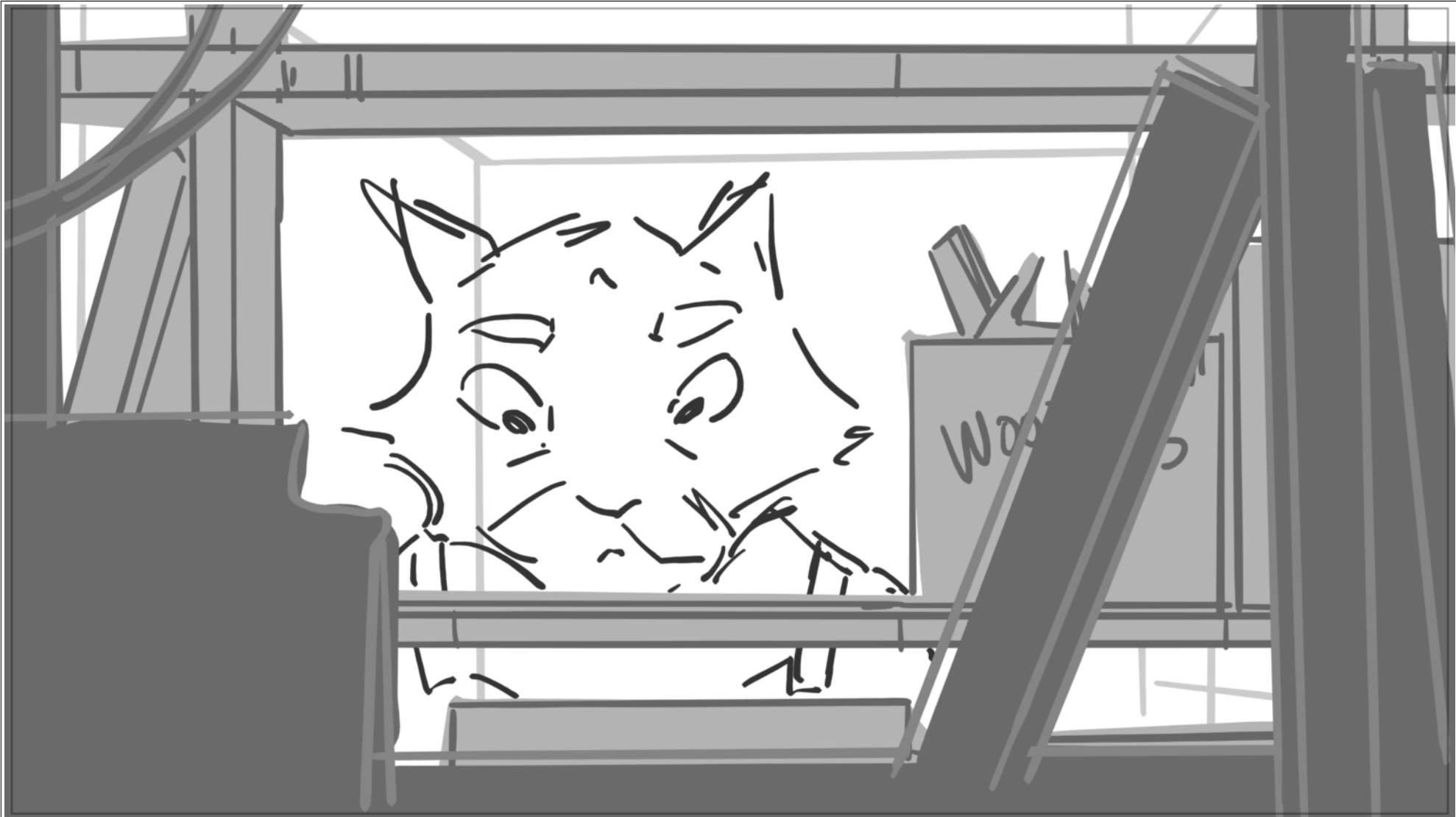

Seq	1		
Scene	Duration	Panel	Duration
9	02:05	4	00:09

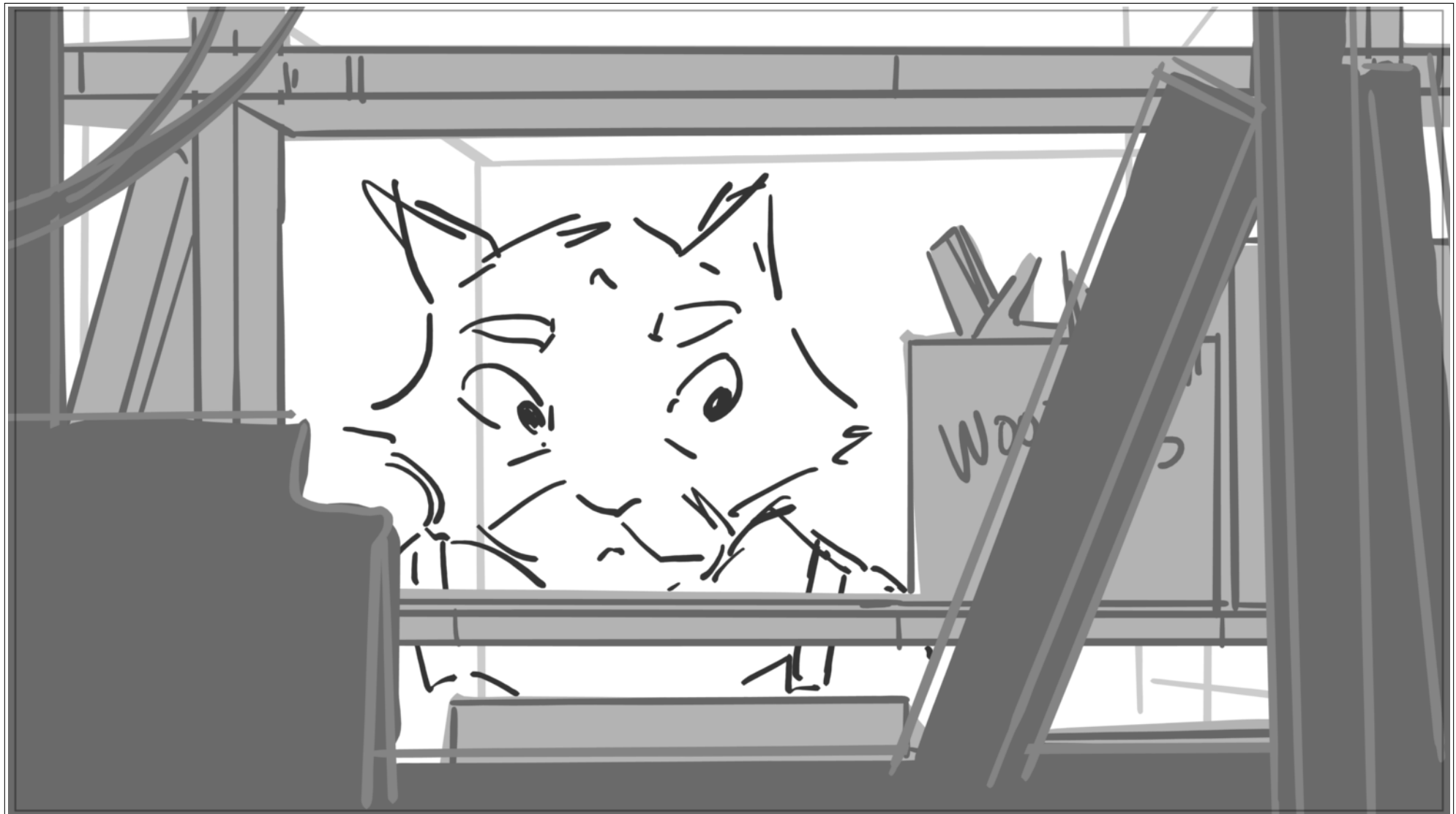

Seq	1		
Scene	Duration	Panel	Duration
9	02:05	5	00:05



Seq	1		
Scene	Duration	Panel	Duration
9	02:05	6	00:10

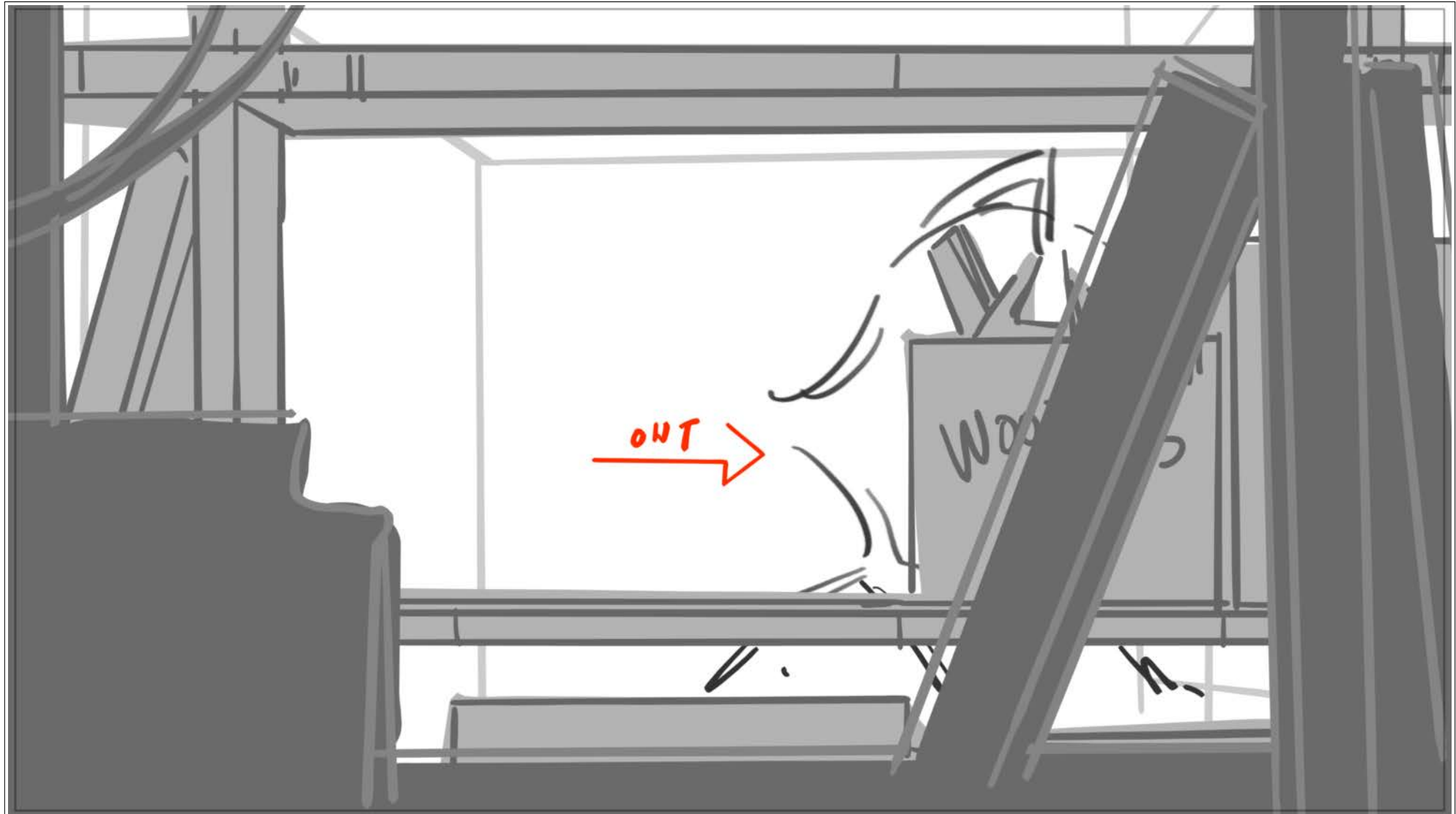

Seq	1		
Scene	Duration	Panel	Duration
10a	01:10	1	01:10

INOUT

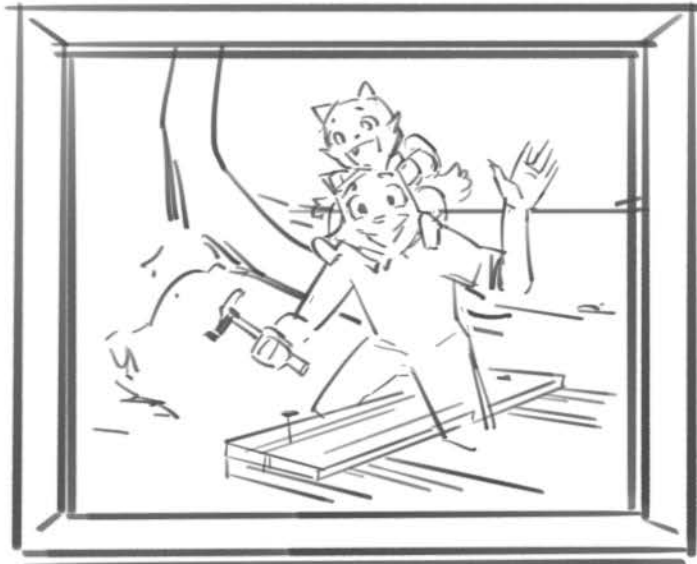
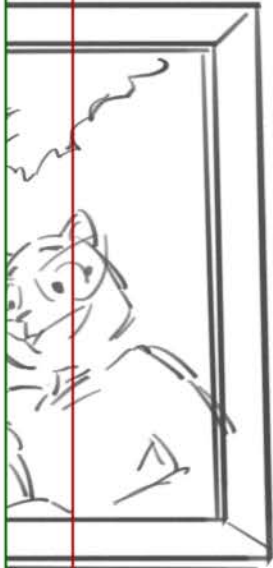

Seq	1		
Scene	Duration	Panel	Duration
10b	01:08	1	01:08



Seq	1		
Scene	Duration	Panel	Duration
10c	00:16	1	00:16



Seq	1		
Scene	Duration	Panel	Duration
10d	01:07	1	01:07



Seq	1		
Scene	Duration	Panel	Duration
10e	01:06	1	01:06



Seq	1		
Scene	Duration	Panel	Duration
10f	01:08	1	01:08

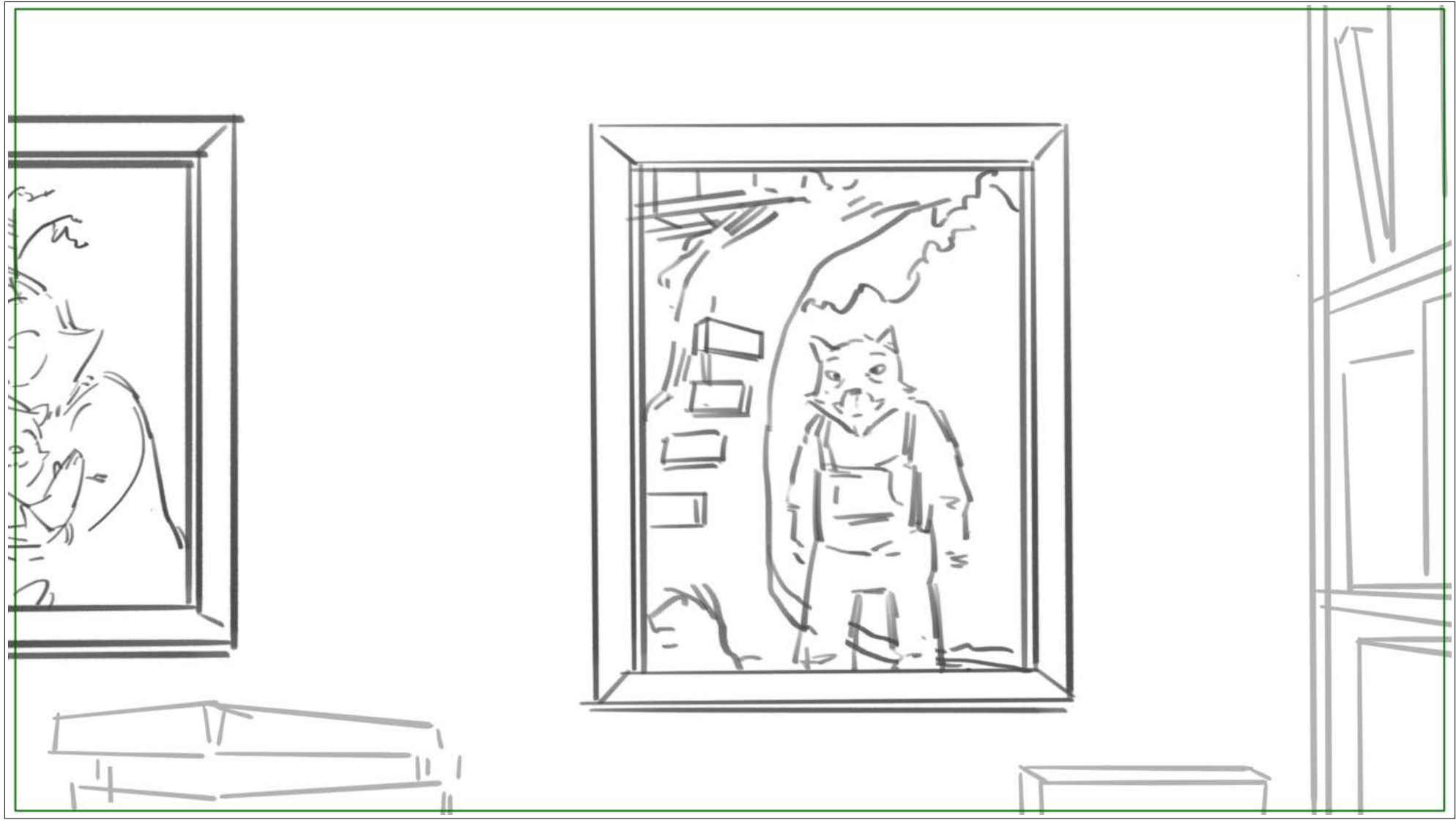

Seq	1		
Scene	Duration	Panel	Duration
10g	00:18	1	00:18



Seq	1		
Scene	Duration	Panel	Duration
11	01:22	1	00:16



Seq	1		
Scene	Duration	Panel	Duration
11	01:22	2	01:06

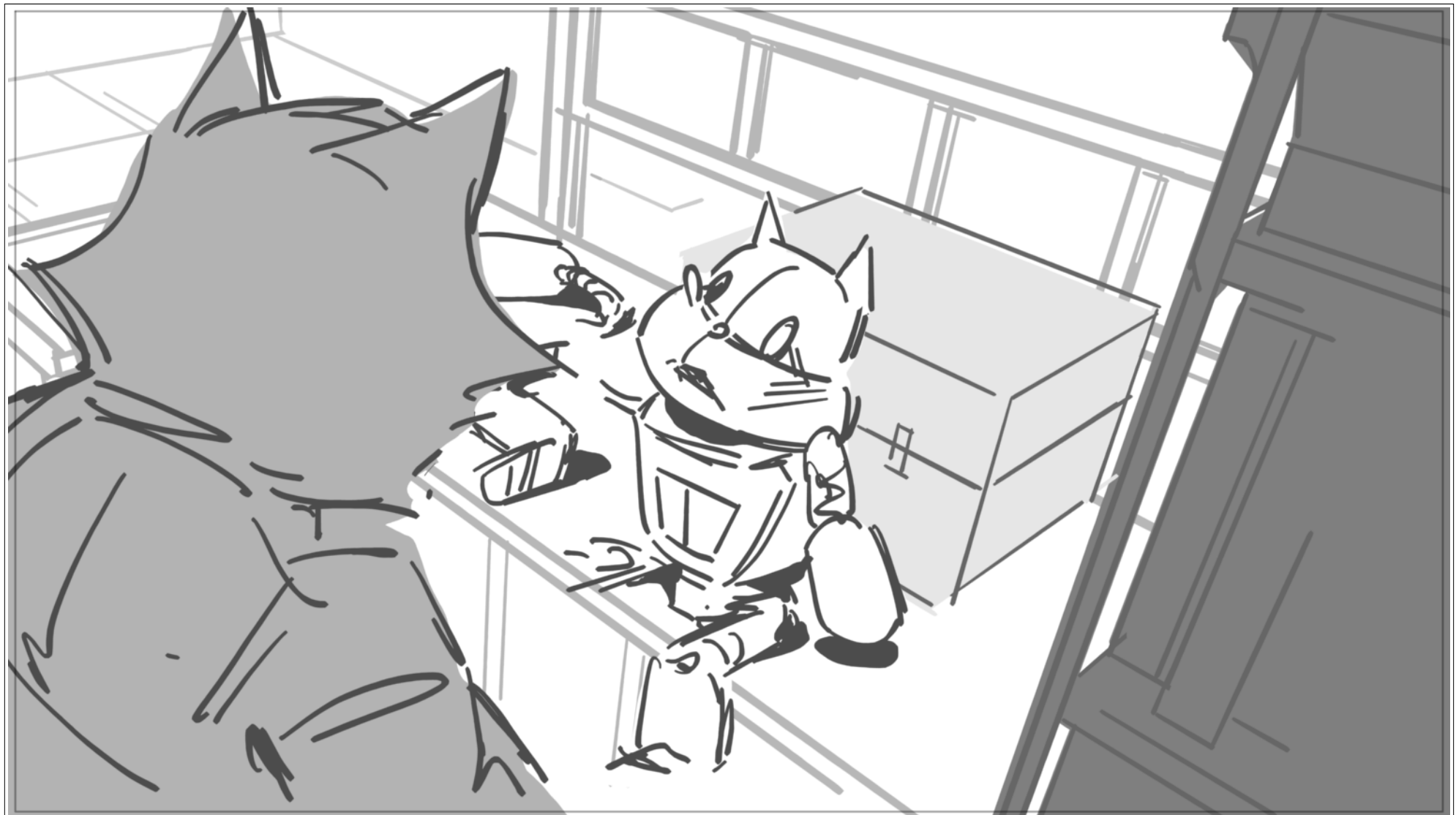

Seq	1		
Scene	Duration	Panel	Duration
12	01:16	1	00:16



Seq	1		
Scene	Duration	Panel	Duration
12	01:16	2	00:06

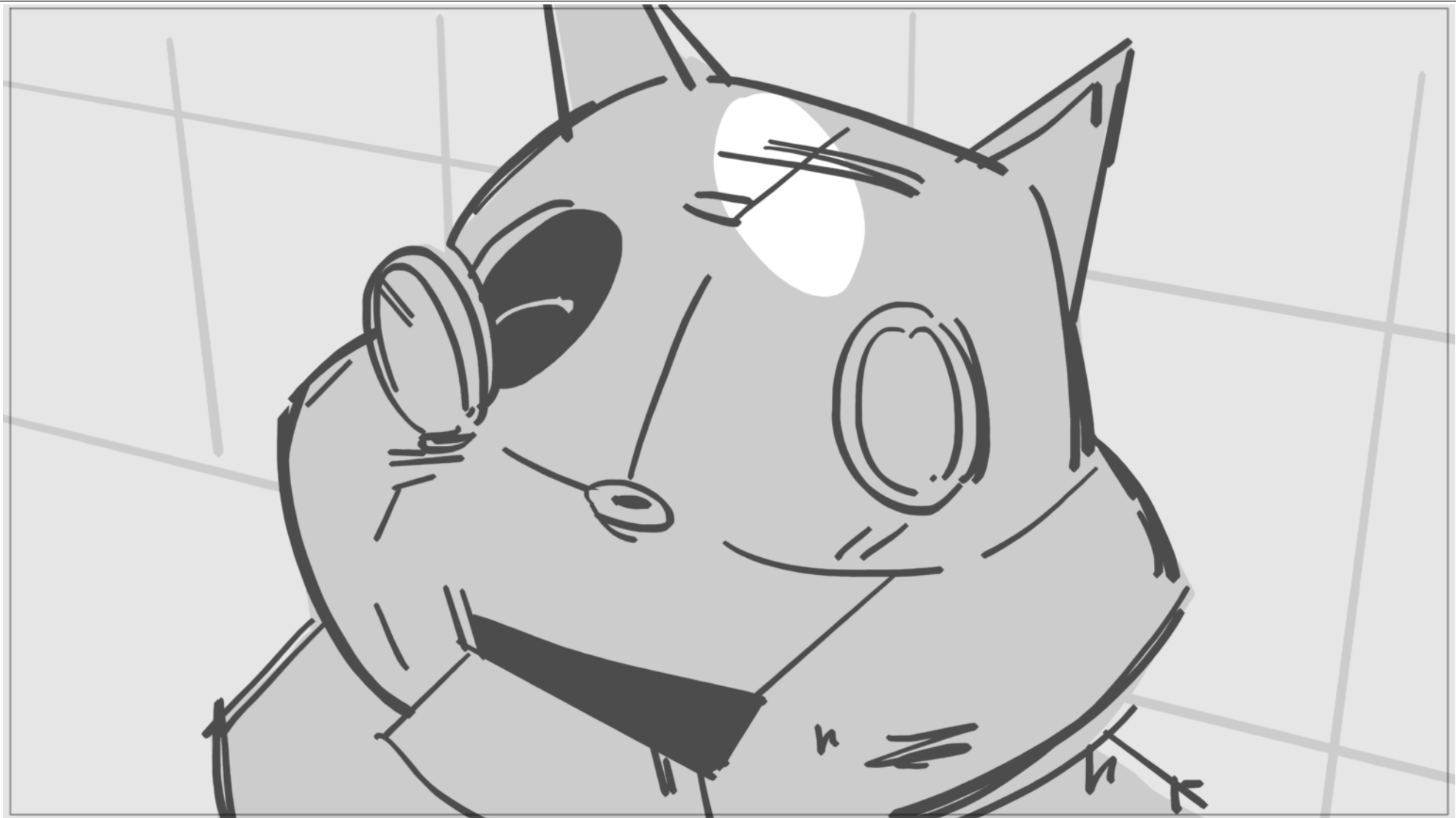

Seq	1		
Scene	Duration	Panel	Duration
12	01:16	3	00:18

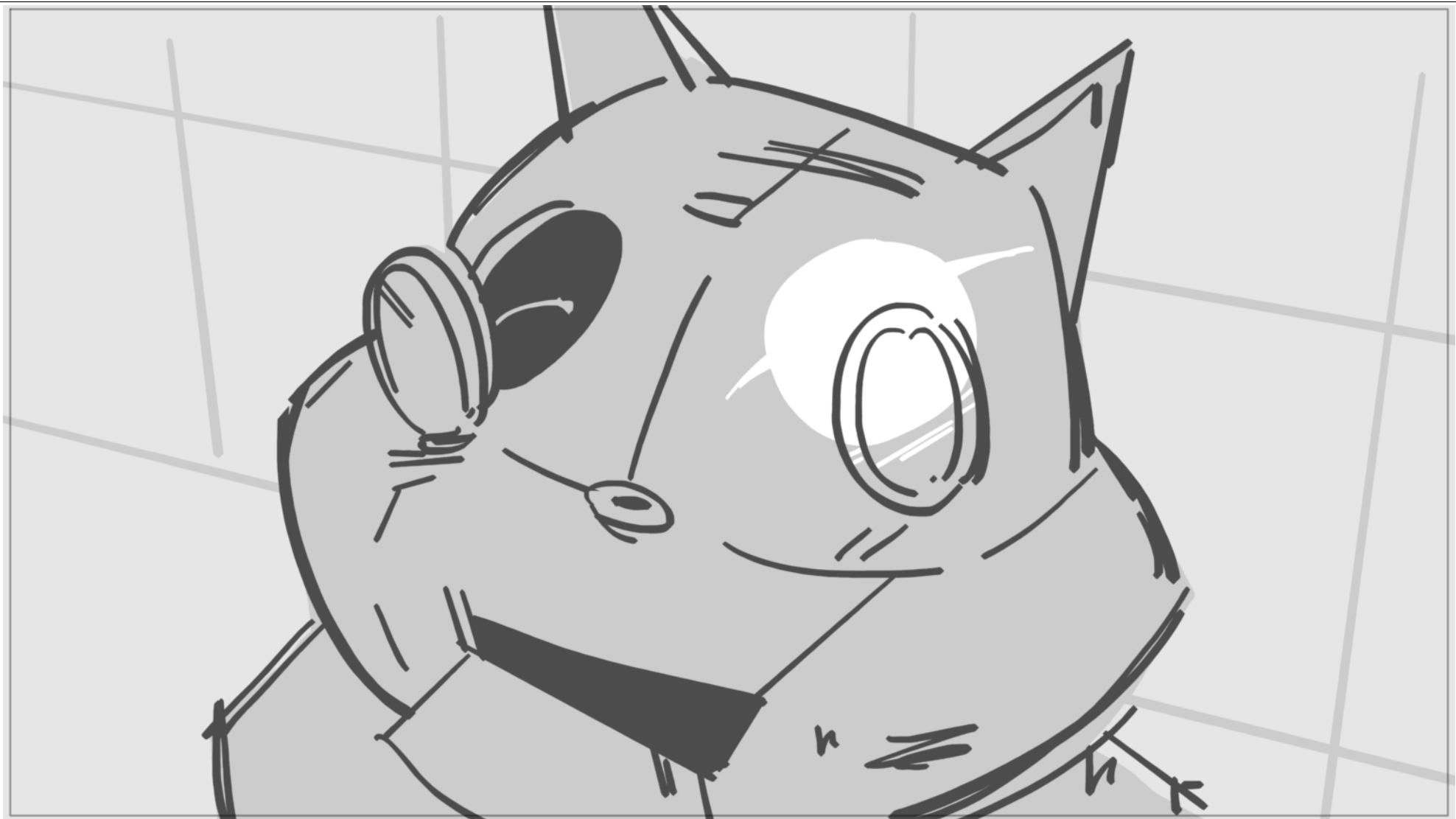

Seq	1		
Scene	Duration	Panel	Duration
13	01:11	1	00:14

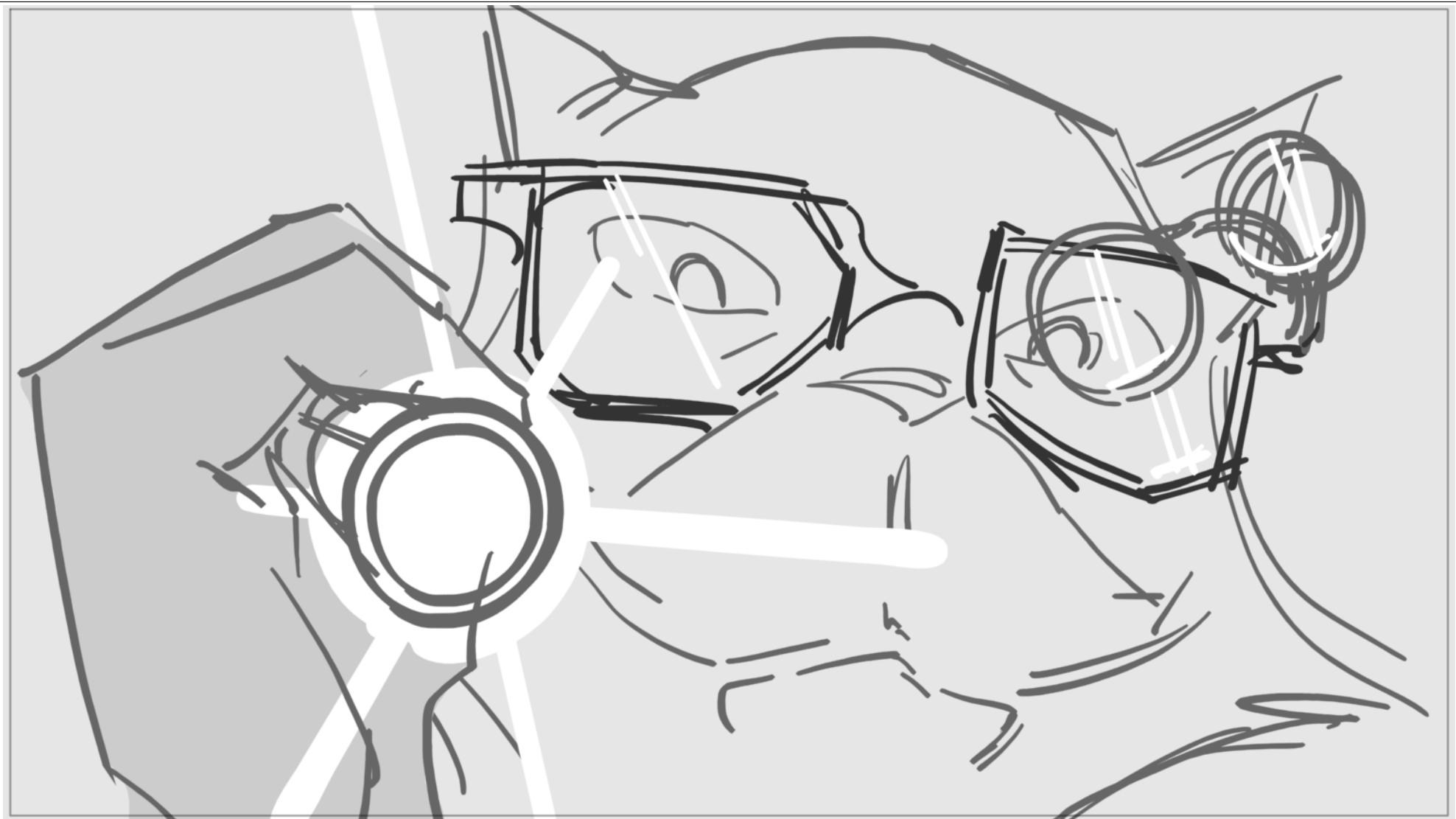

Seq	1		
Scene	Duration	Panel	Duration
13	01:11	2	00:04

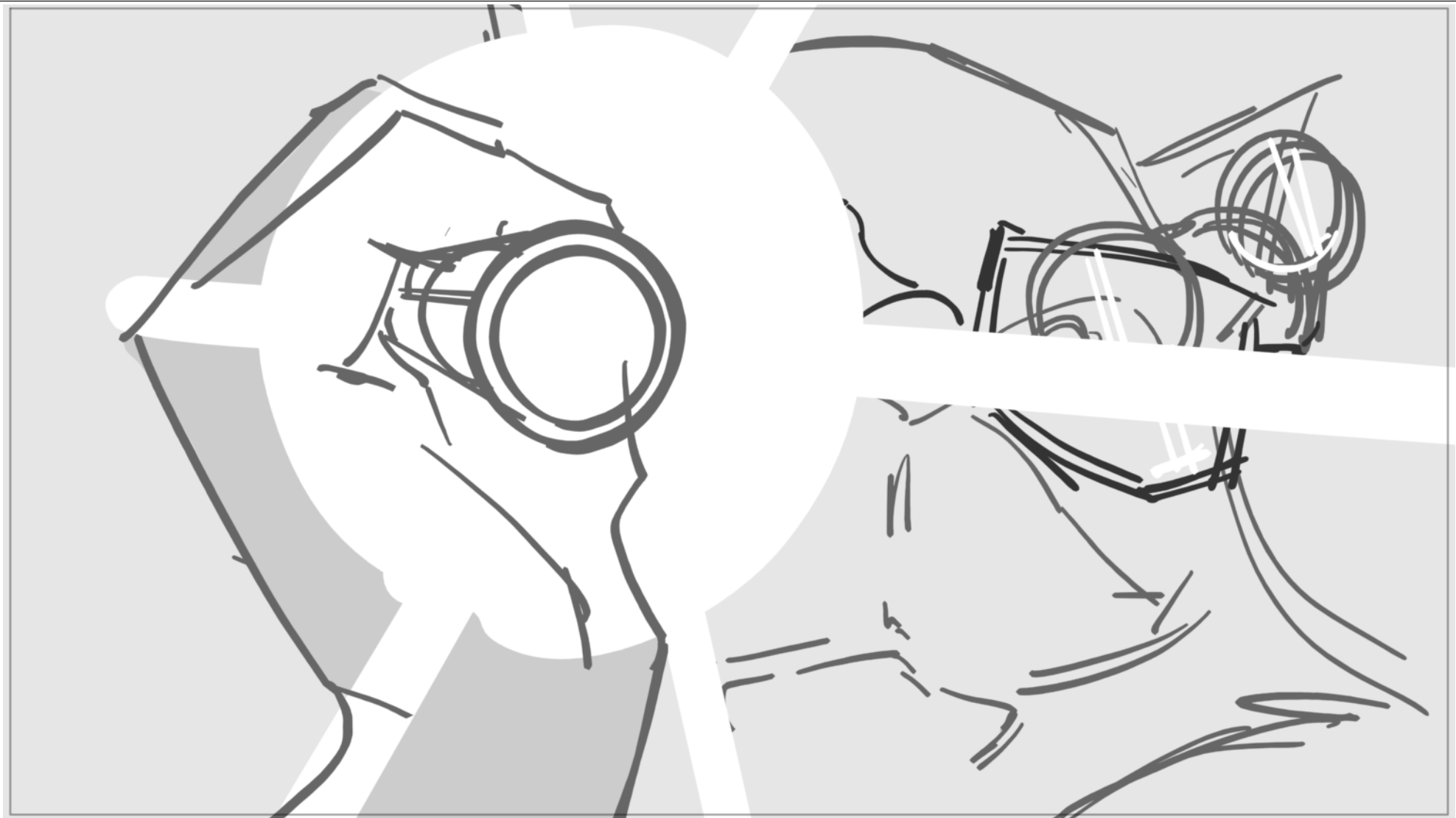

Seq	1		
Scene	Duration	Panel	Duration
13	01:11	3	00:17

Dia

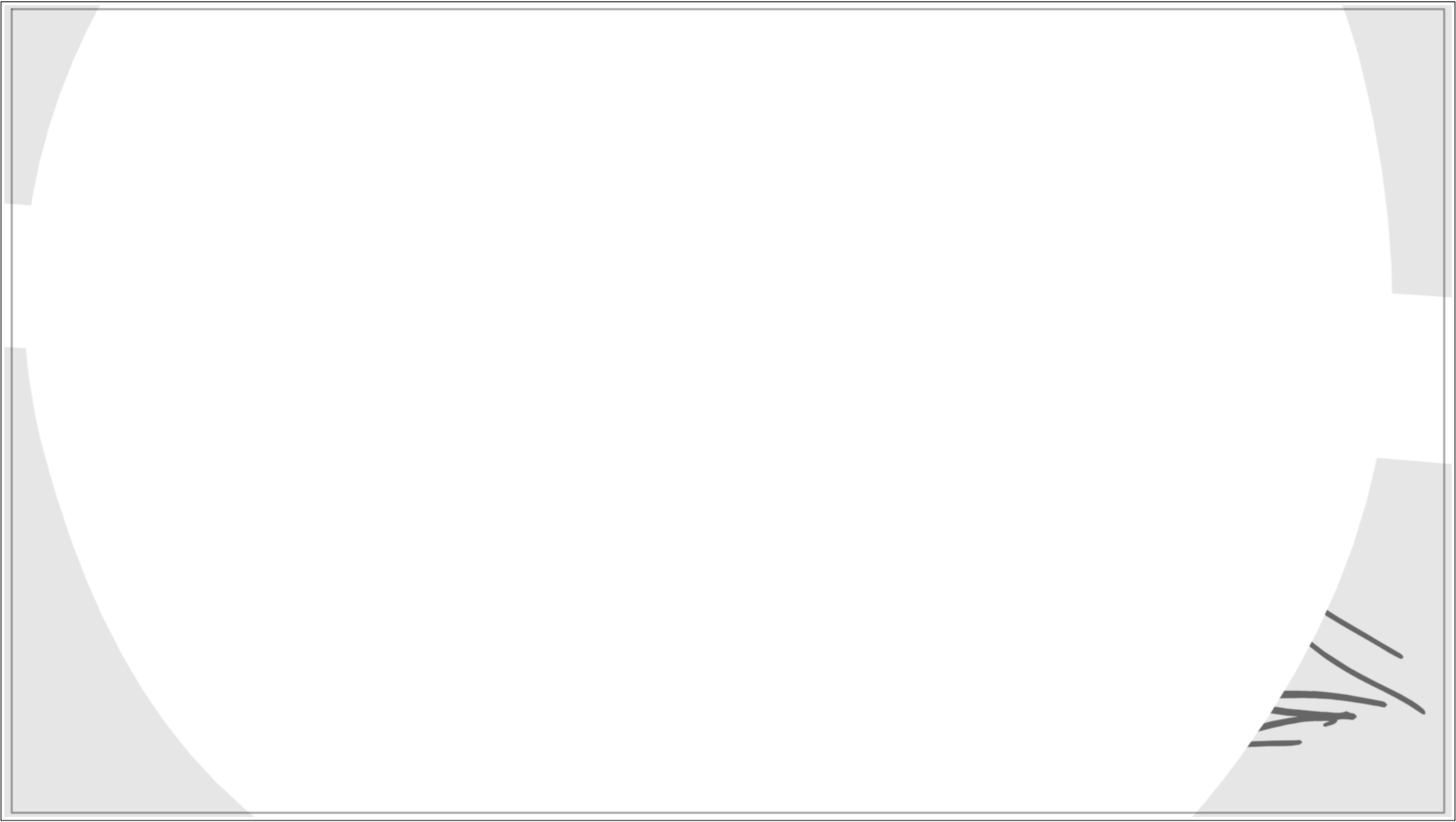

Seq	1		
Scene	Duration	Panel	Duration
14	02:18	1	01:09

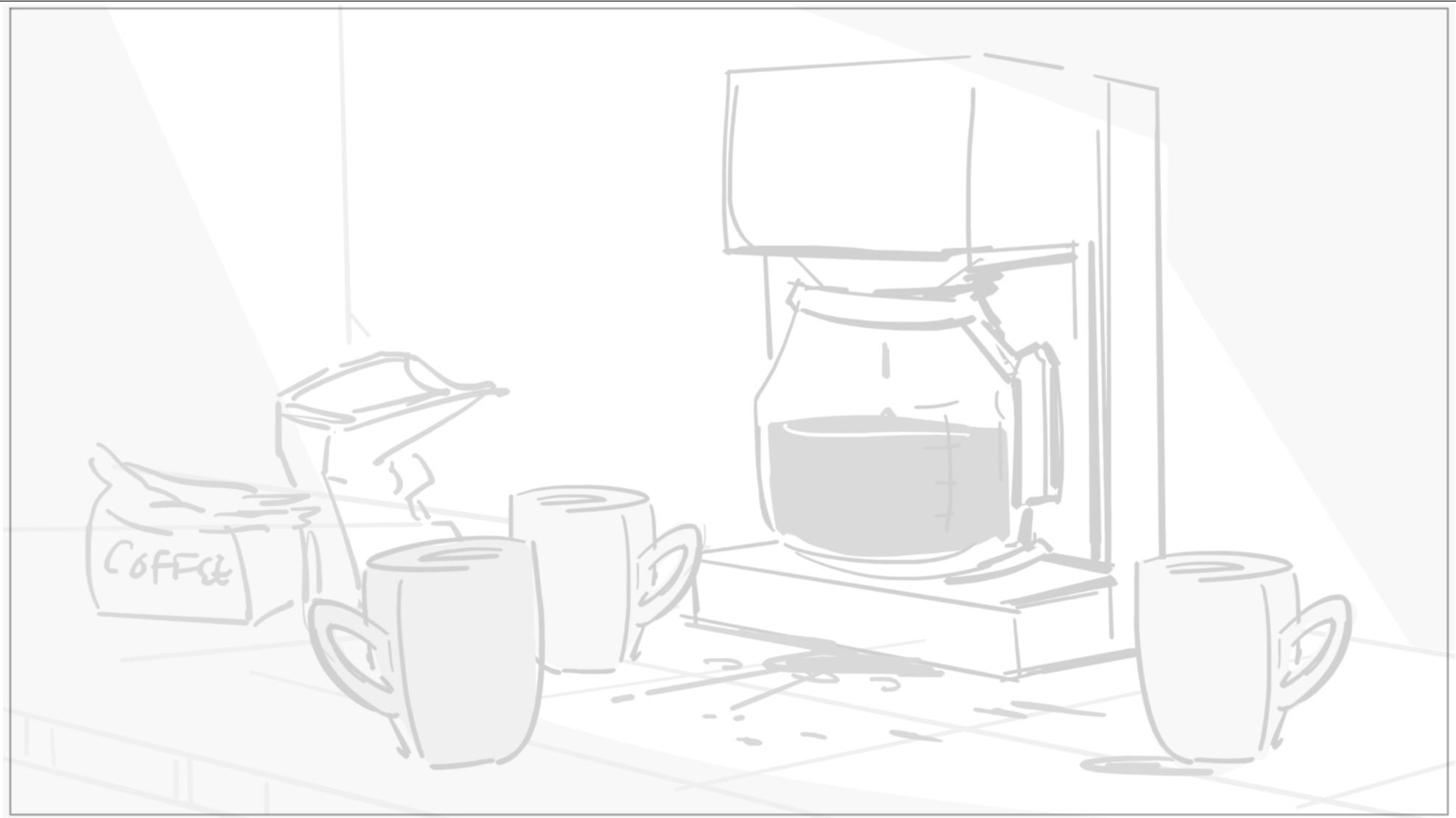

Seq	1		
Scene	Duration	Panel	Duration
14	02:18	2	01:09

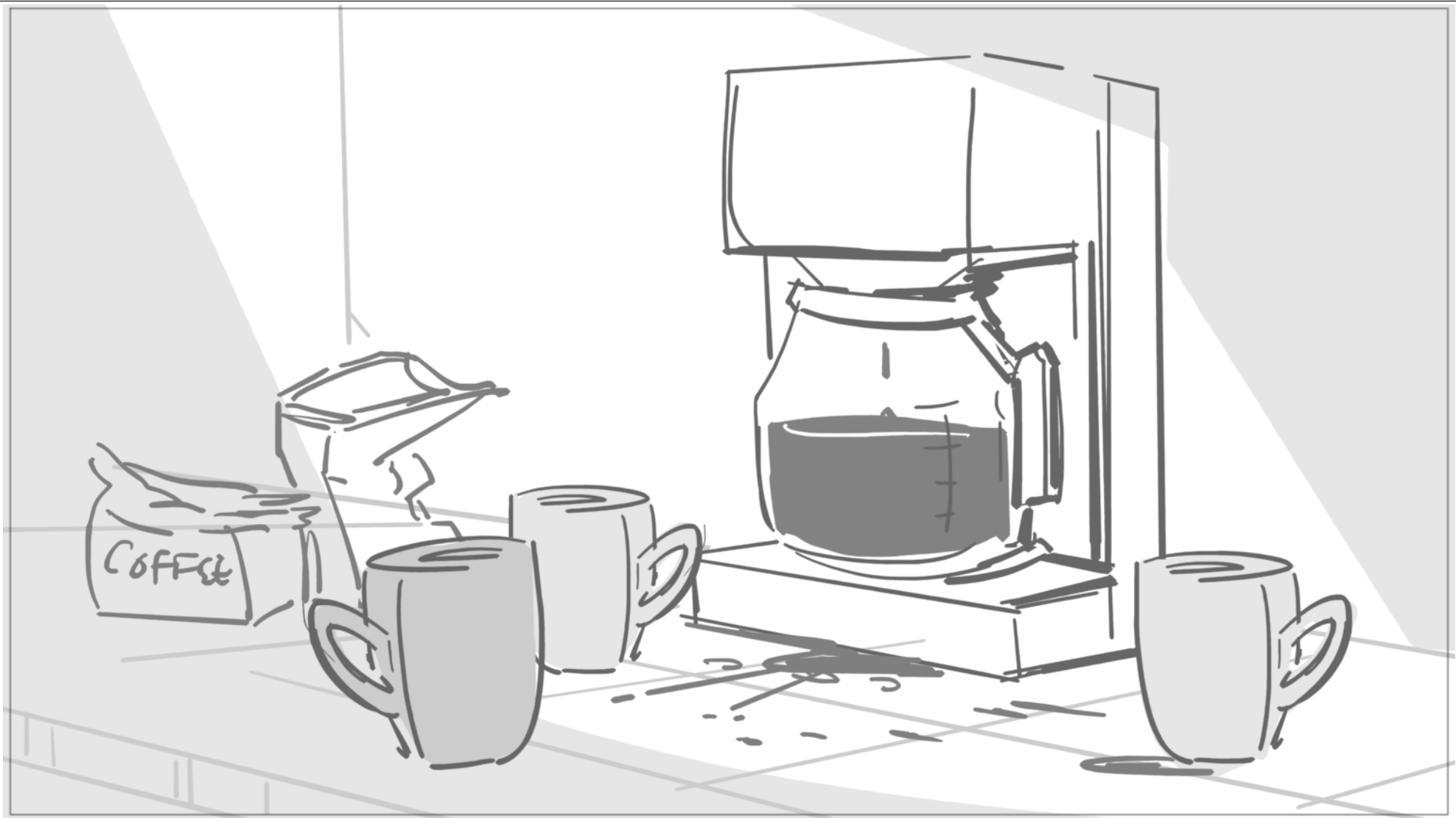

Seq	1		
Scene	Duration	Panel	Duration
14	02:18	2	01:09

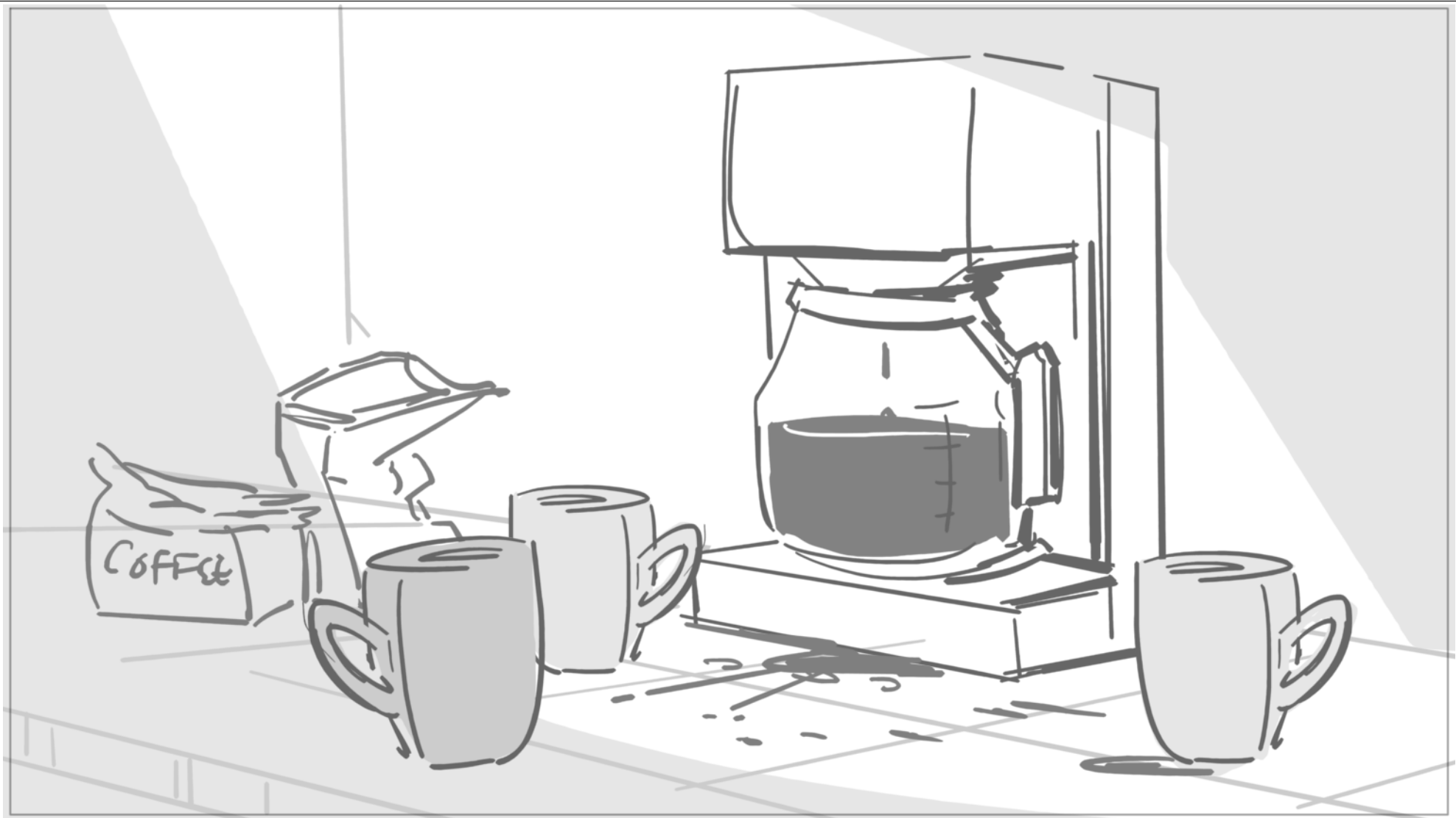

Seq	1		
Scene	Duration	Panel	Duration
15	01:14	1	01:14

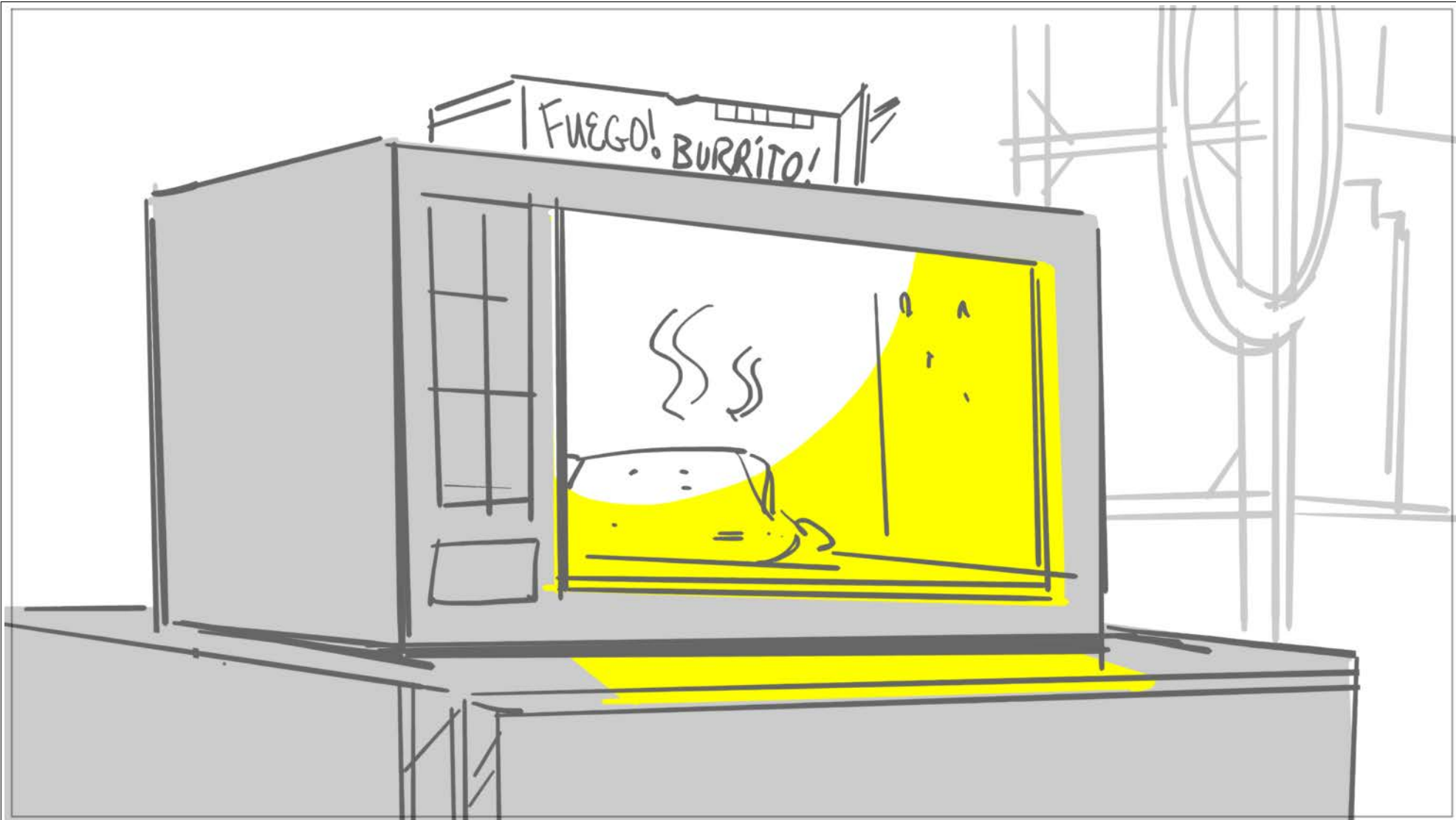

Seq	1		
Scene	Duration	Panel	Duration
16	01:16	1	01:16

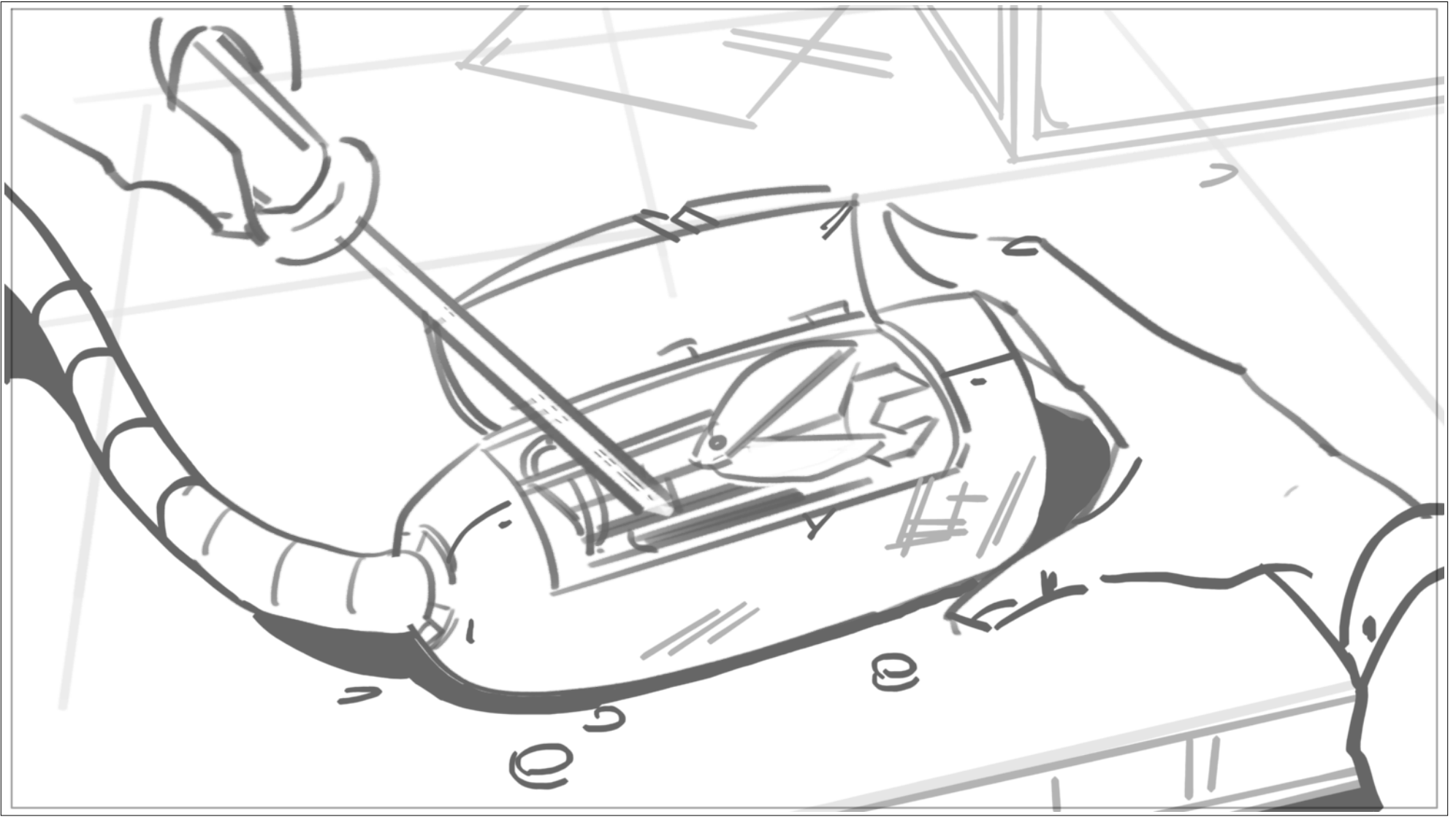

Seq	1		
Scene	Duration	Panel	Duration
17	05:04	1	00:21



Seq	1		
Scene	Duration	Panel	Duration
17	05:04	2	00:06



Seq	1		
Scene	Duration	Panel	Duration
17	05:04	3	00:04



Seq	1		
Scene	Duration	Panel	Duration
17	05:04	4	00:04



Seq	1		
Scene	Duration	Panel	Duration
17	05:04	5	00:05



Seq	1		
Scene	Duration	Panel	Duration
17	05:04	6	00:04



Seq	1		
Scene	Duration	Panel	Duration
17	05:04	7	00:04



Seq	1		
Scene	Duration	Panel	Duration
17	05:04	8	00:06



Seq	1		
Scene	Duration	Panel	Duration
17	05:04	9	00:04

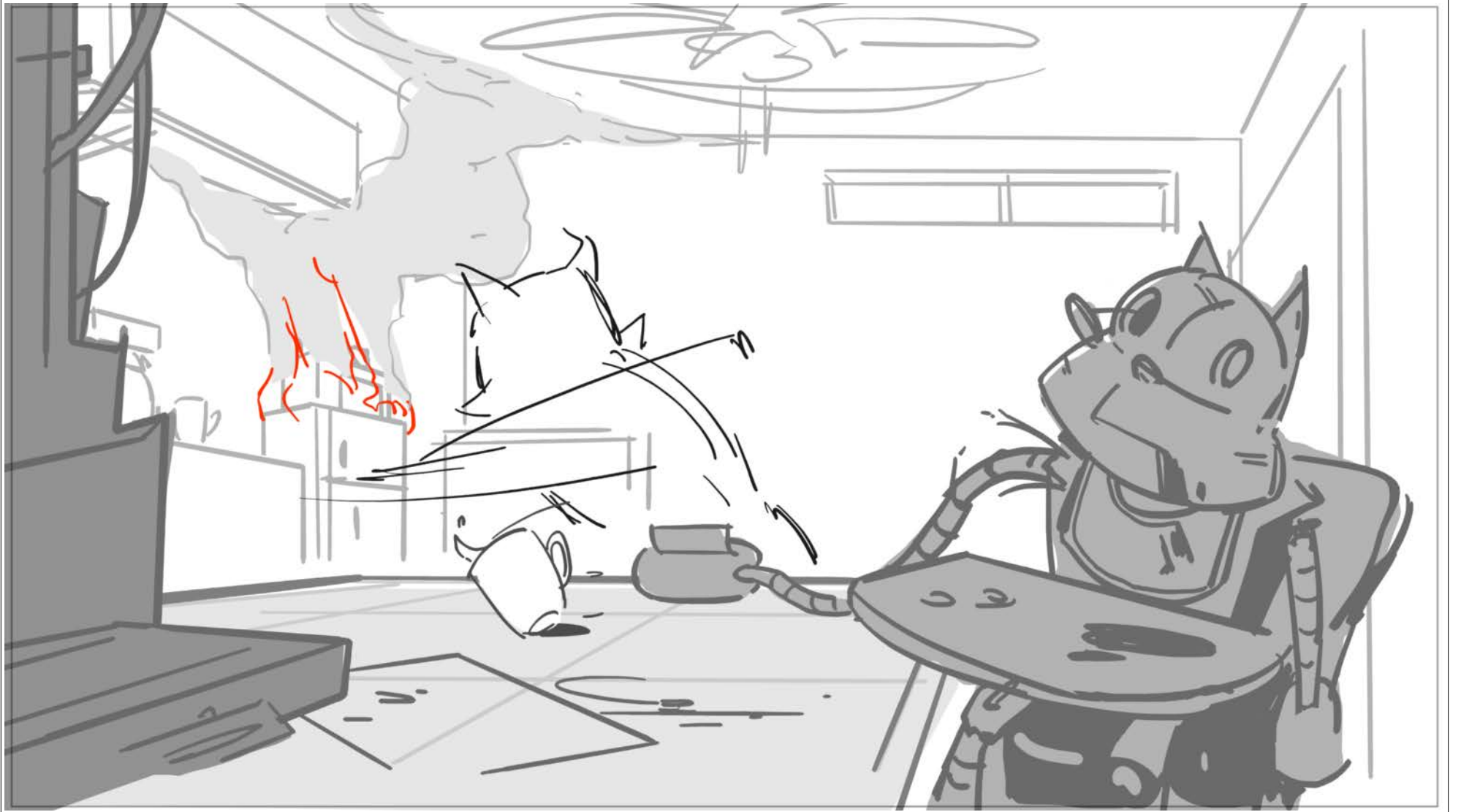

Seq	1		
Scene	Duration	Panel	Duration
17	05:04	10	00:04

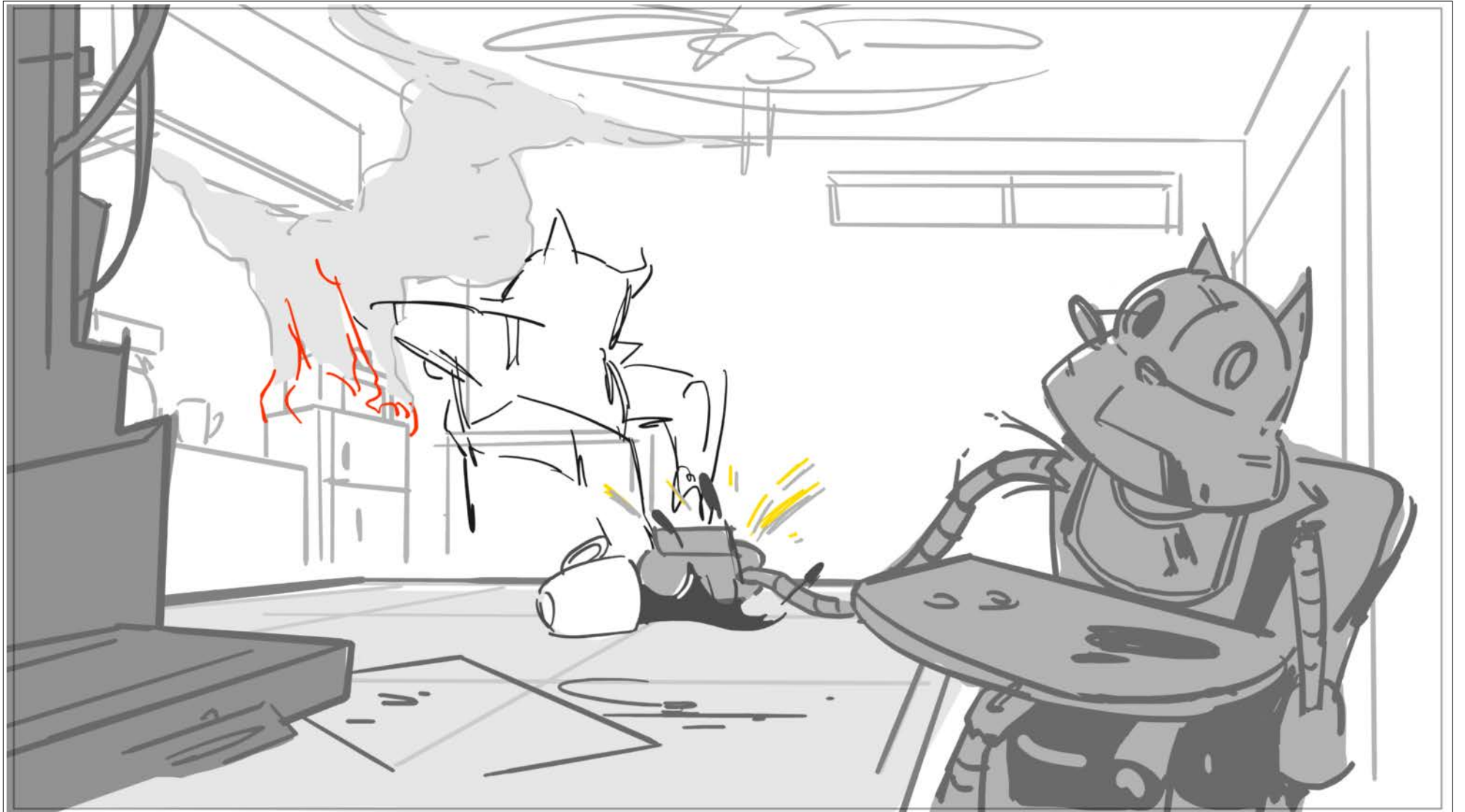

Seq	1		
Scene	Duration	Panel	Duration
17	05:04	11	00:04

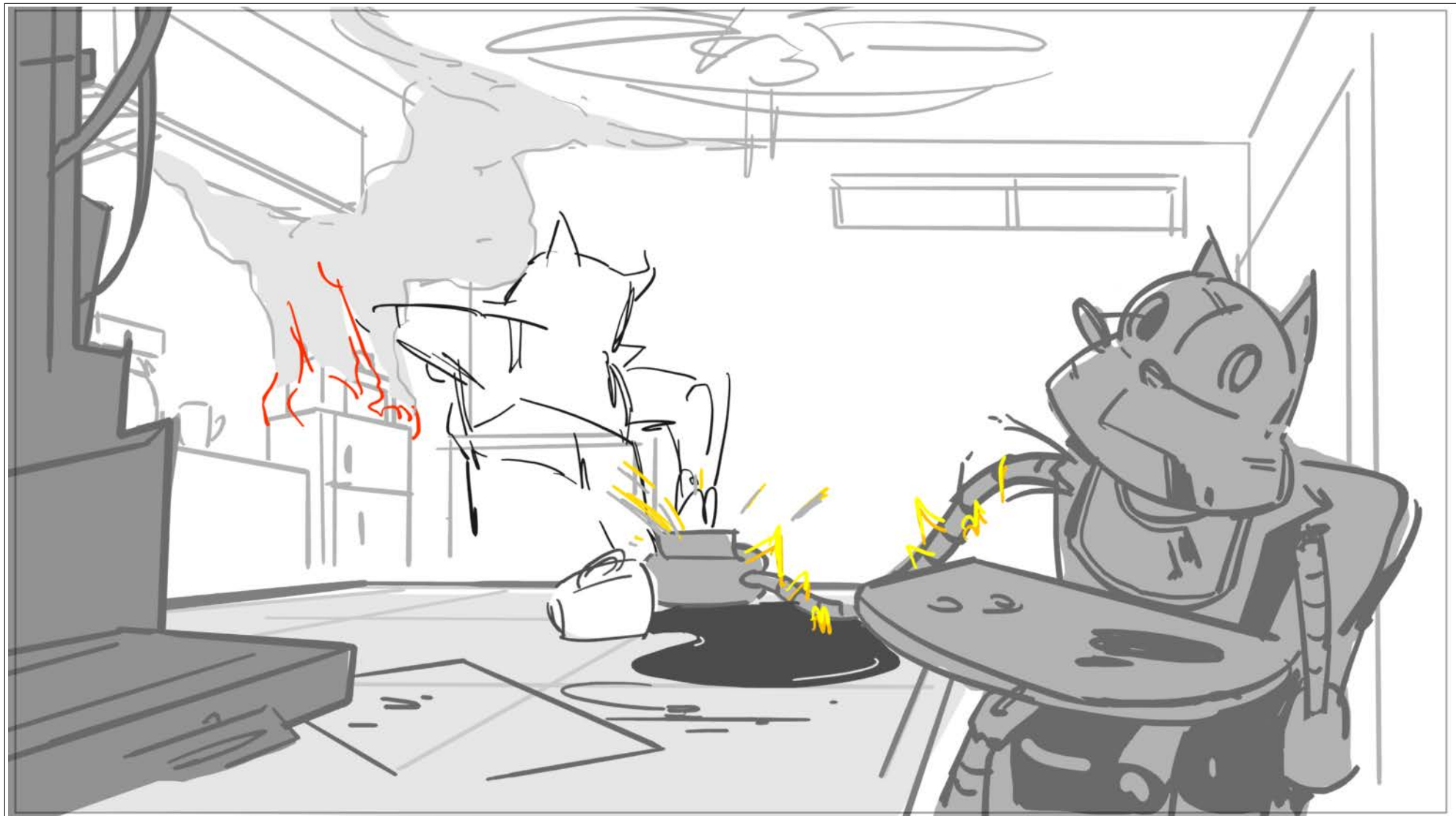

Seq	1		
Scene	Duration	Panel	Duration
17	05:04	12	00:04

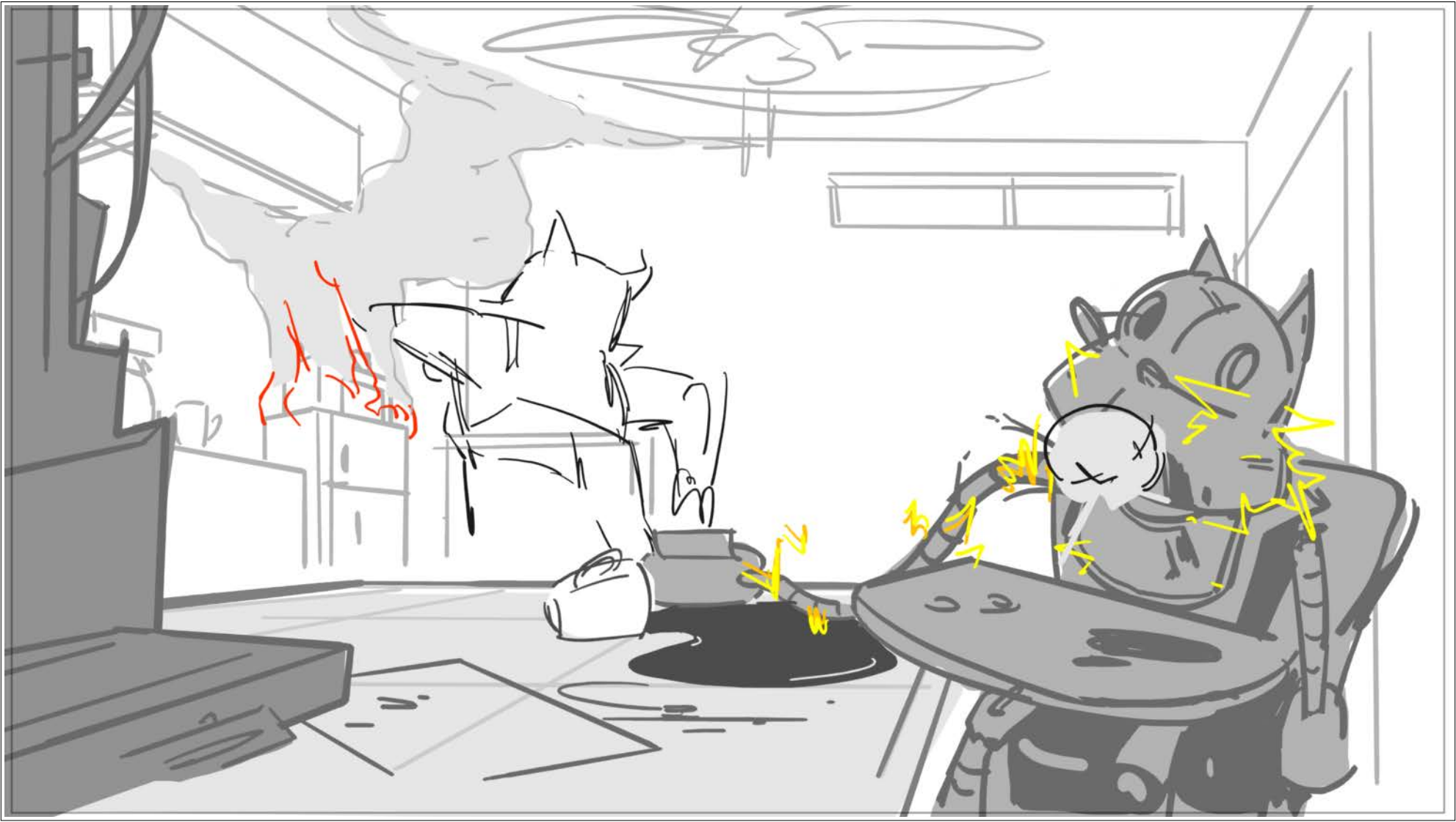

Seq	1		
Scene	Duration	Panel	Duration
17	05:04	13	00:04

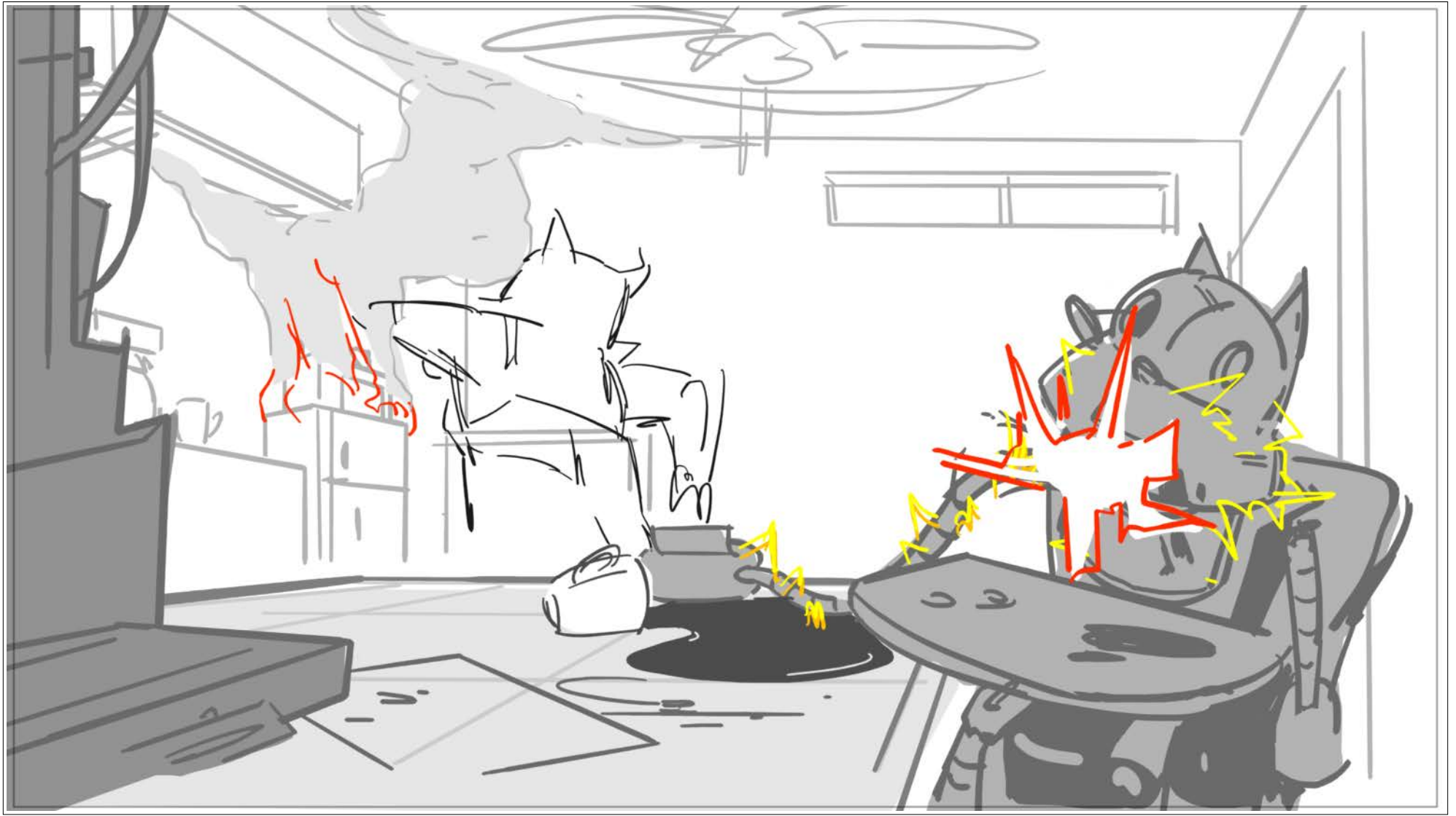

Seq	1		
Scene	Duration	Panel	Duration
17	05:04	14	00:06

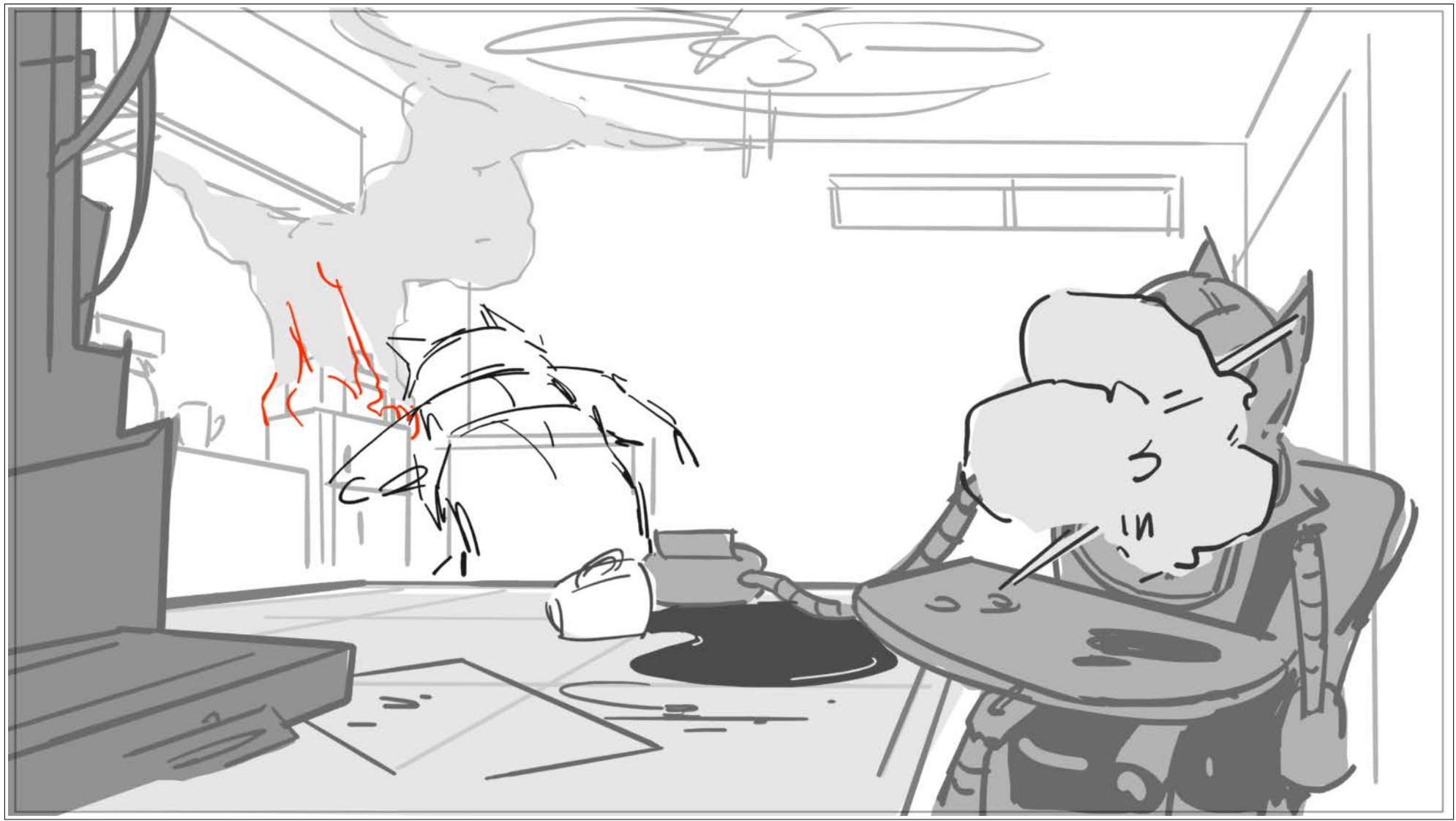

Seq	1			
Scene	Duration	Panel	Duration	Dia
17	05:04	15	00:04	

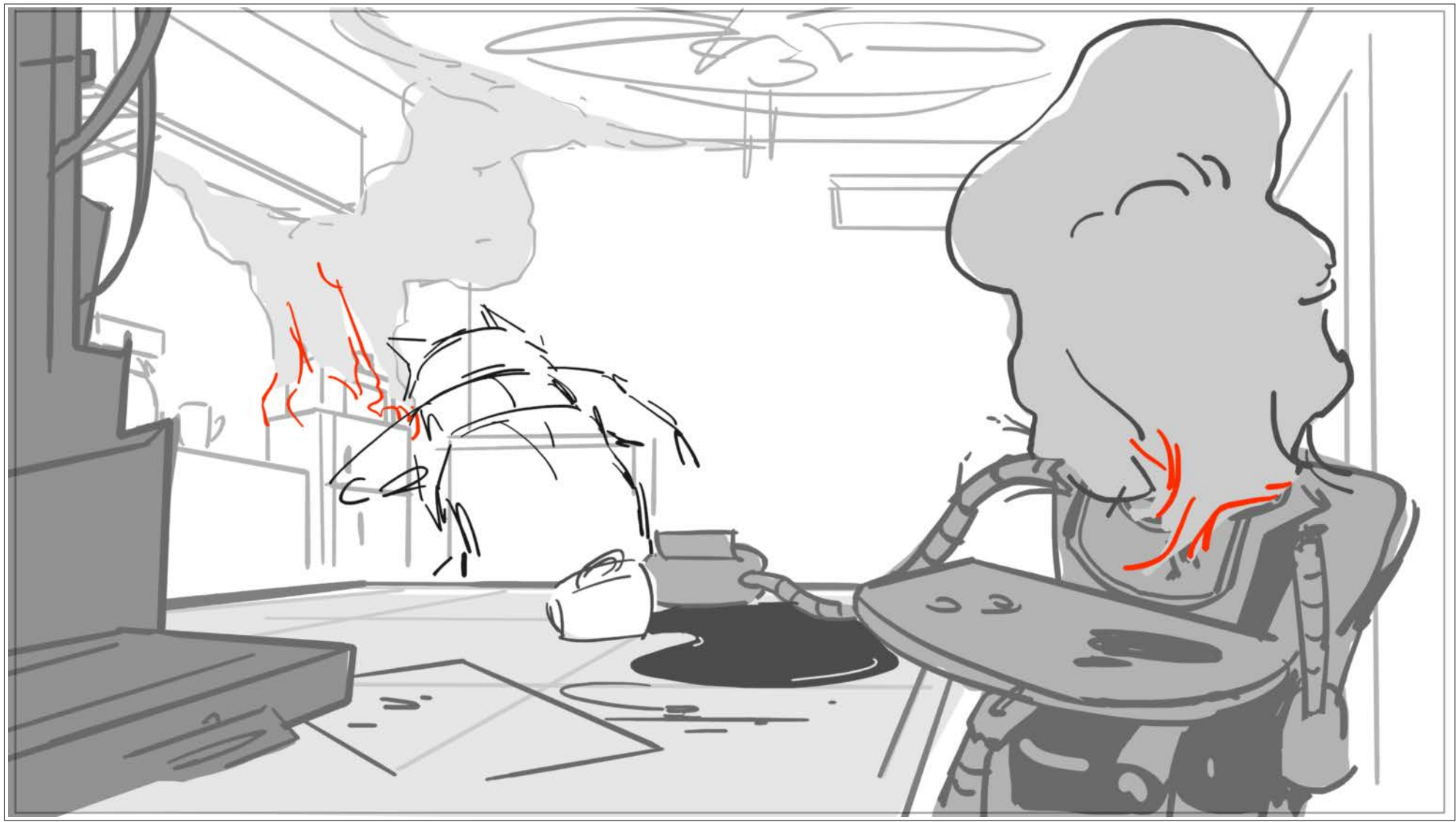

Seq	1			
Scene	Duration	Panel	Duration	Dia
17	05:04	16	00:12	

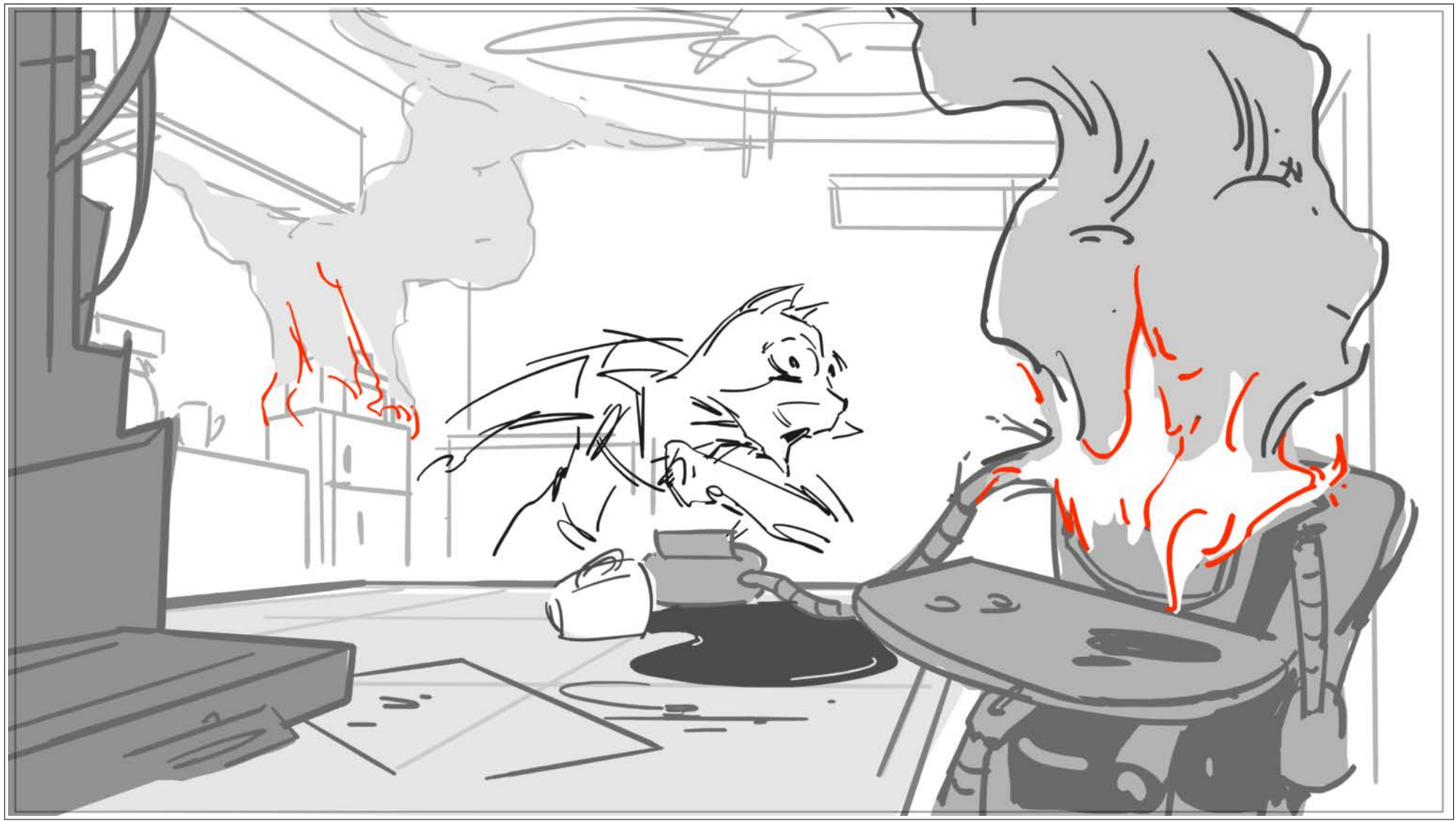

Seq	1		
Scene	Duration	Panel	Duration
17	05:04	17	00:08

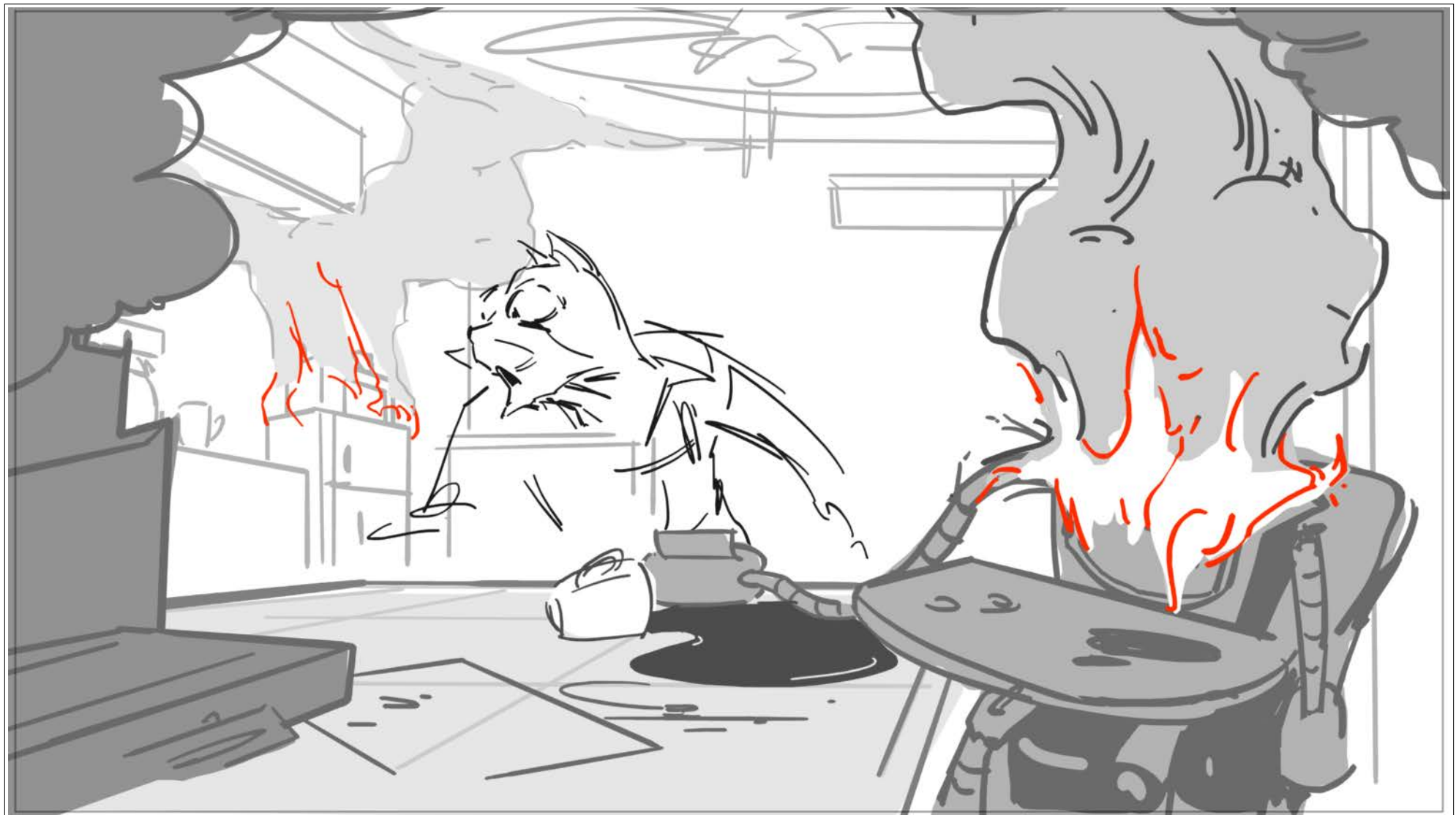

Seq	1		
Scene	Duration	Panel	Duration
17	05:04	18	00:08

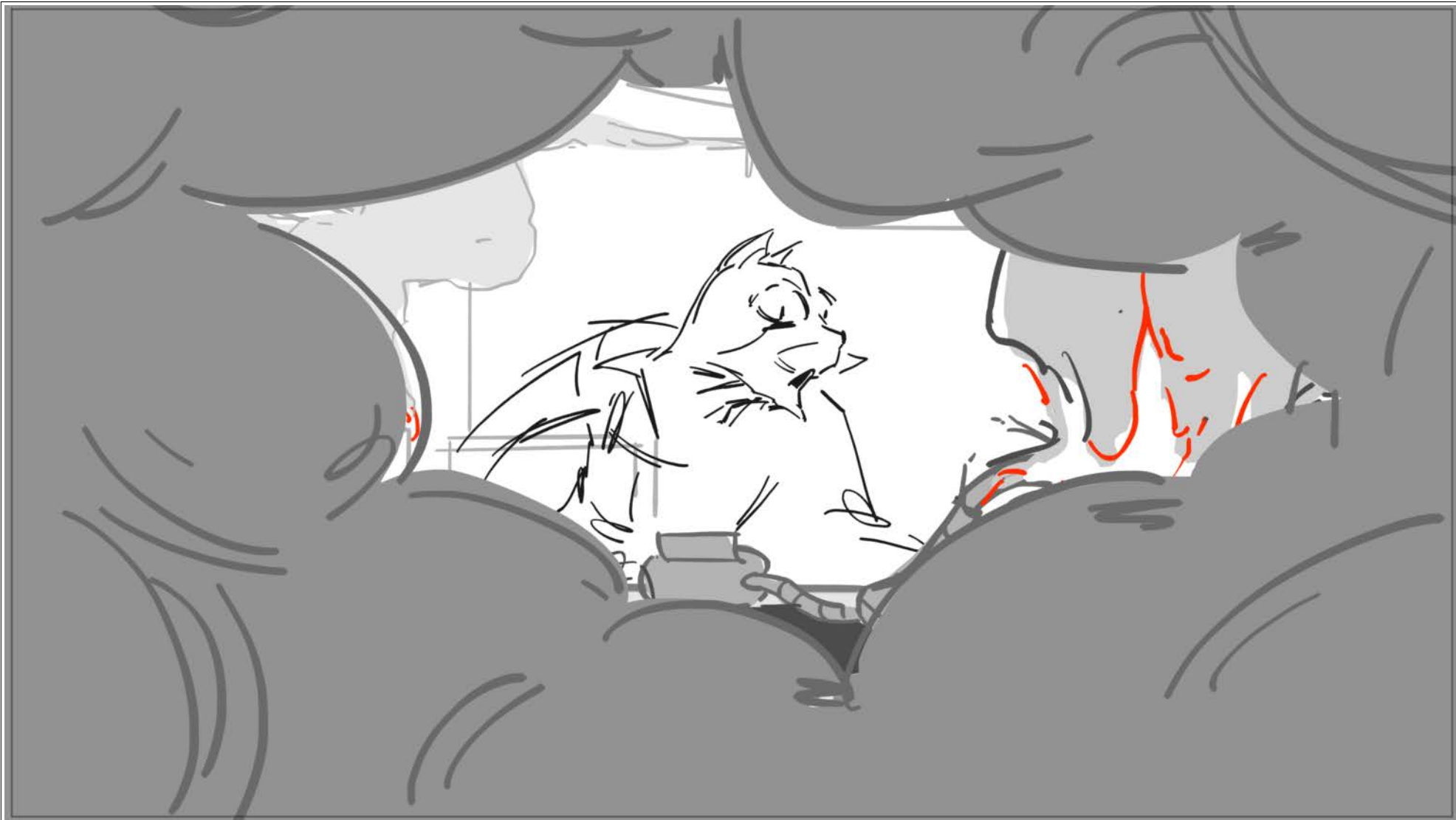

Seq		1	
Scene	Duration	Panel	Duration
17	05:04	19	00:12

Dia

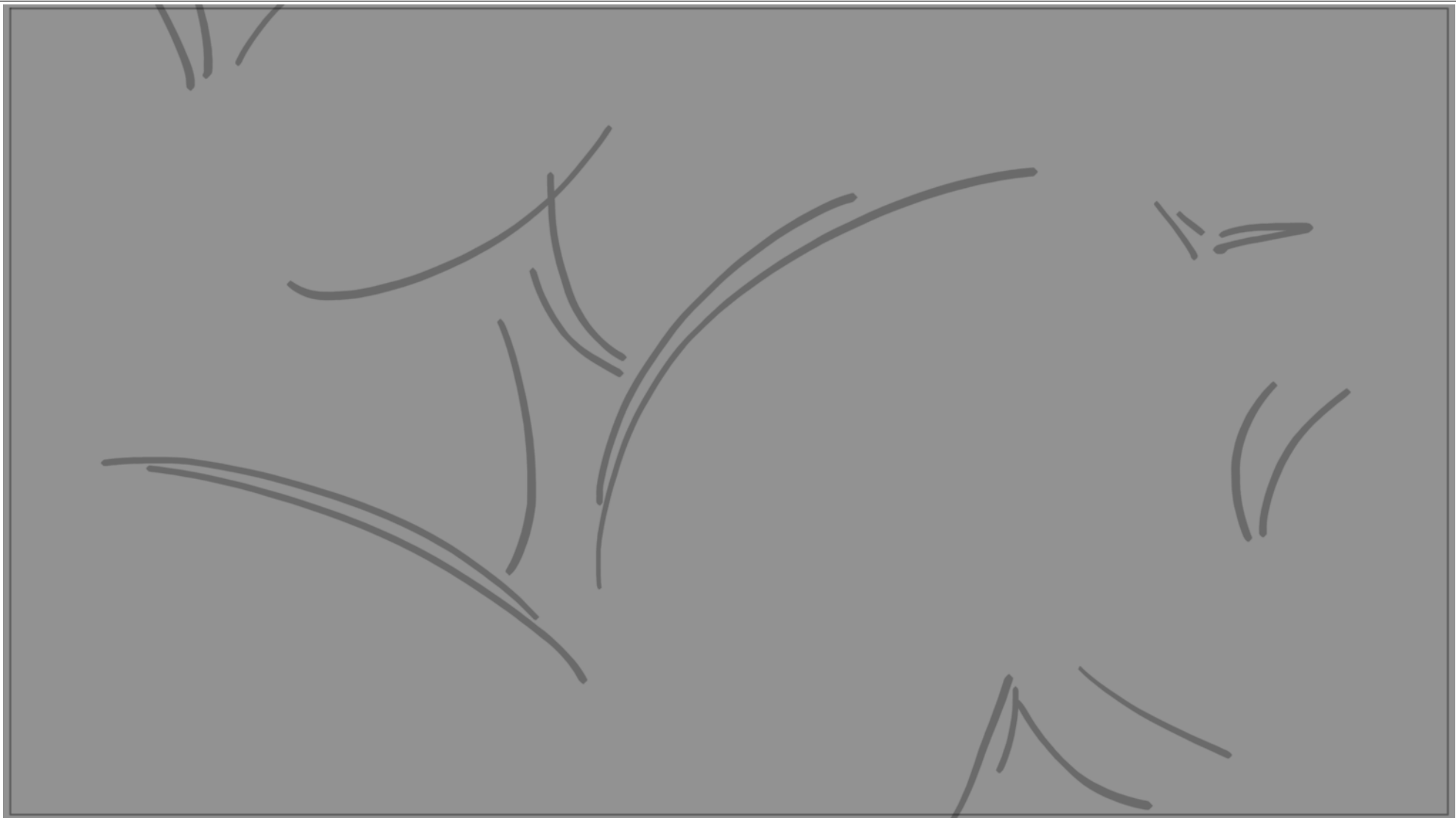

Seq	1		
Scene	Duration	Panel	Duration
18	00:12	1	00:12

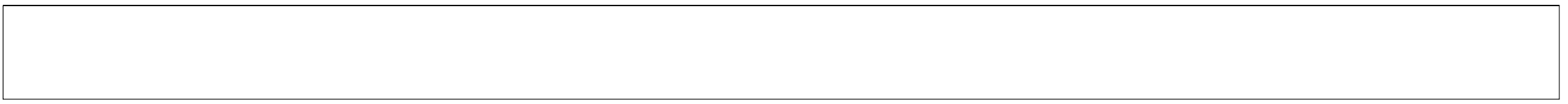
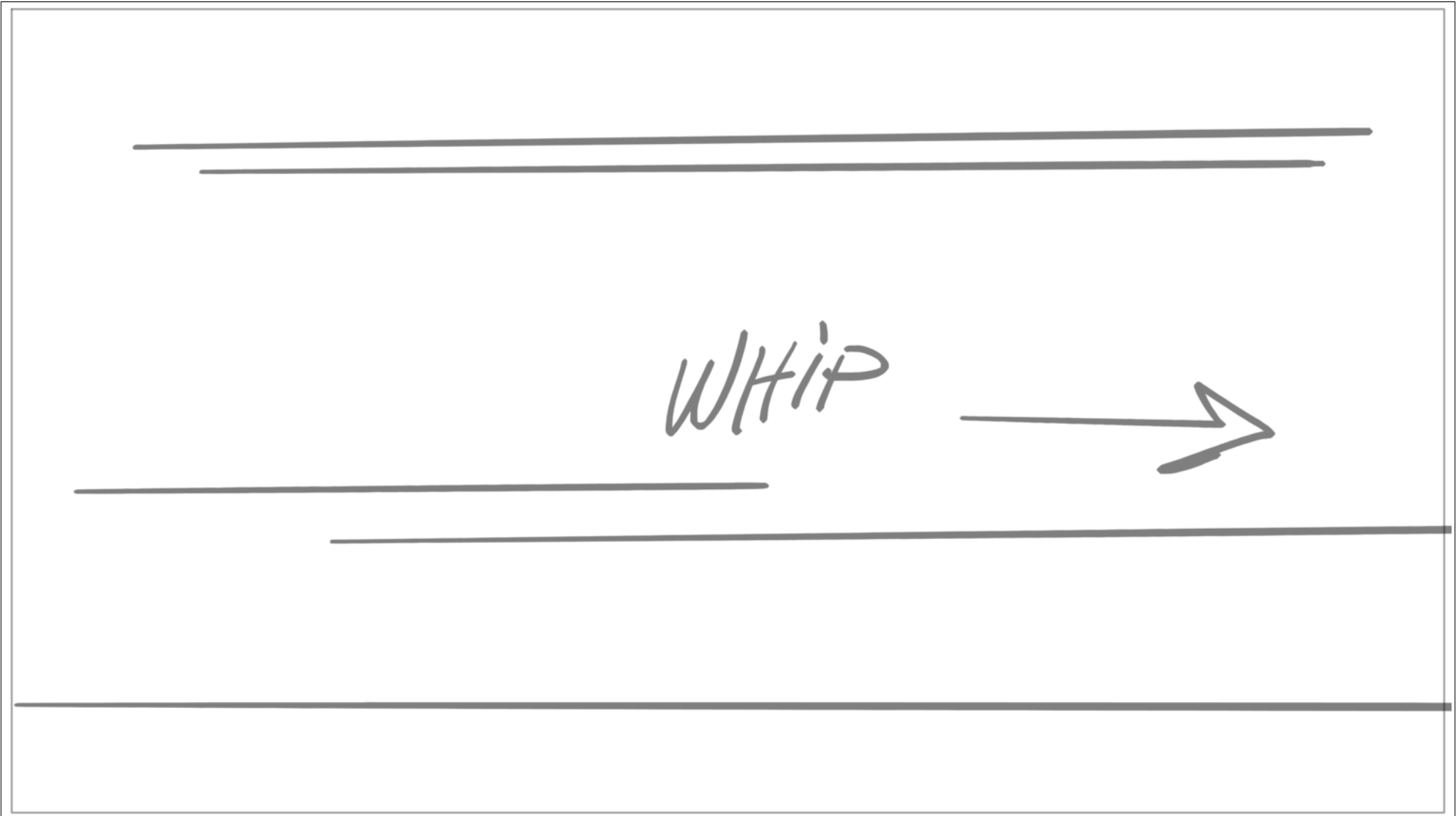

Seq	1		
Scene	Duration	Panel	Duration
19	01:09	1	00:13



Seq	1		
Scene	Duration	Panel	Duration
19	01:09	2	00:20



Seq	1		
Scene	Duration	Panel	Duration
20	03:10	1	00:12

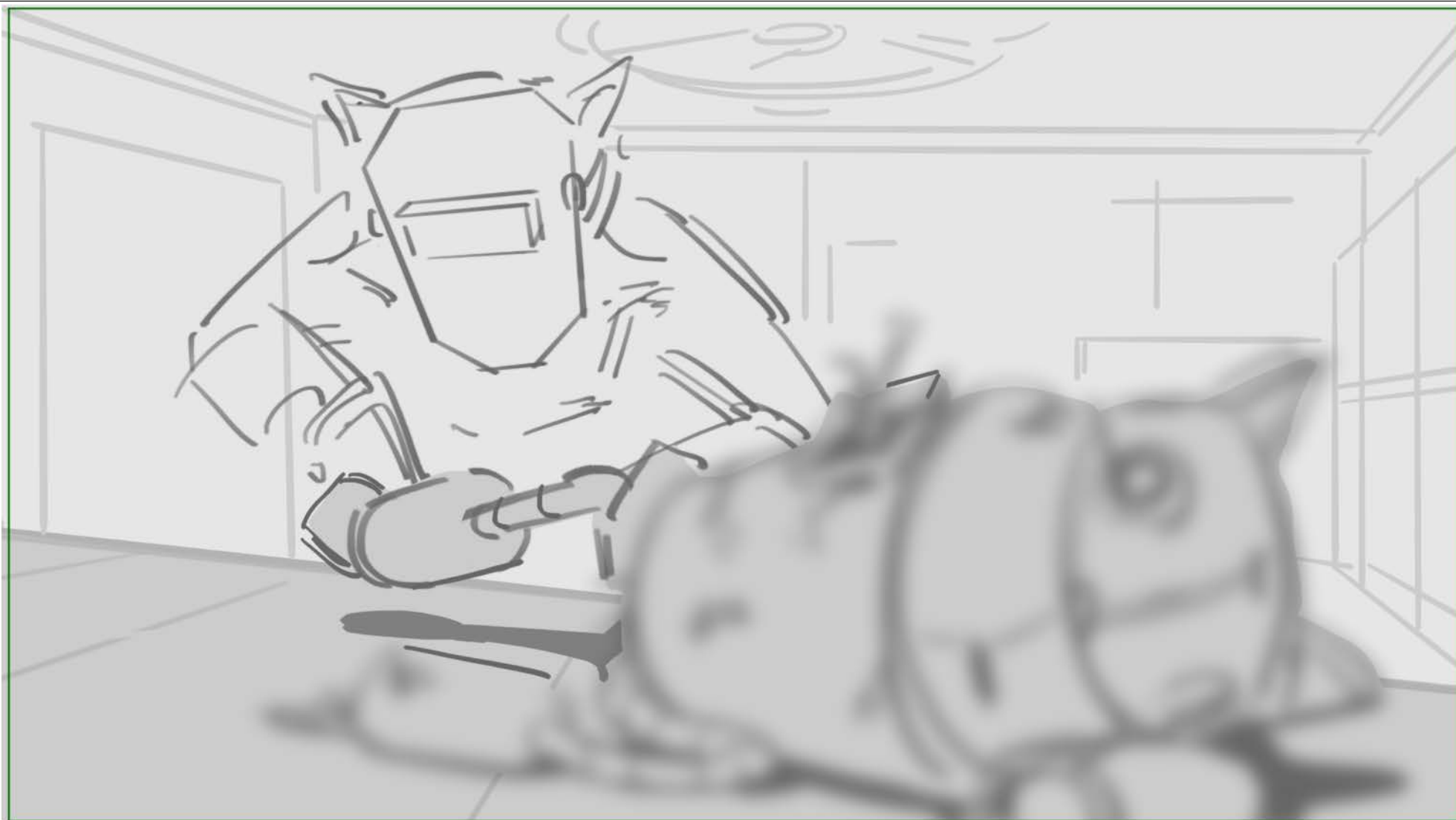

Seq	1		
Scene	Duration	Panel	Duration
20	03:10	2	00:04

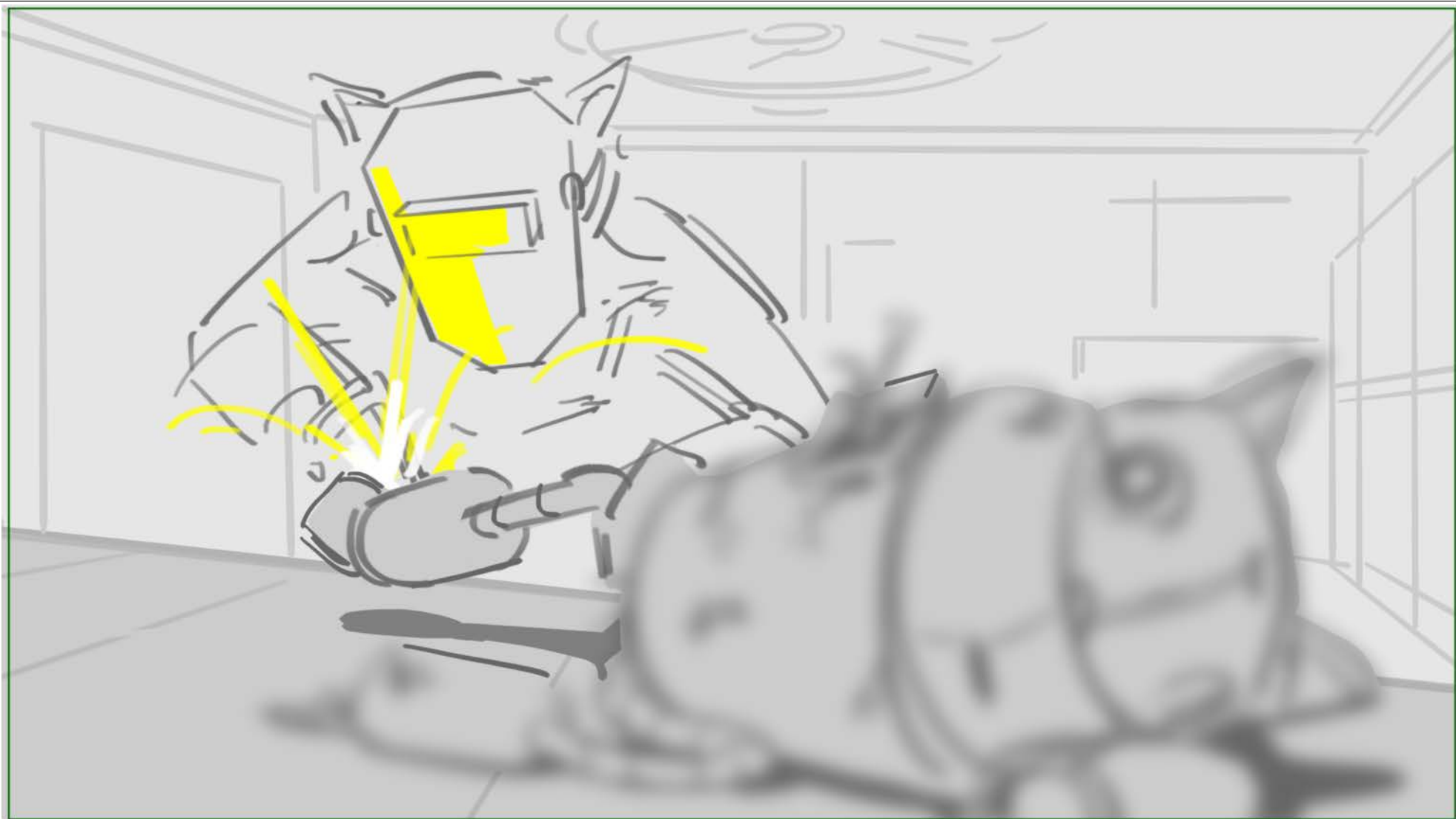

Seq	1		
Scene	Duration	Panel	Duration
20	03:10	3	00:04

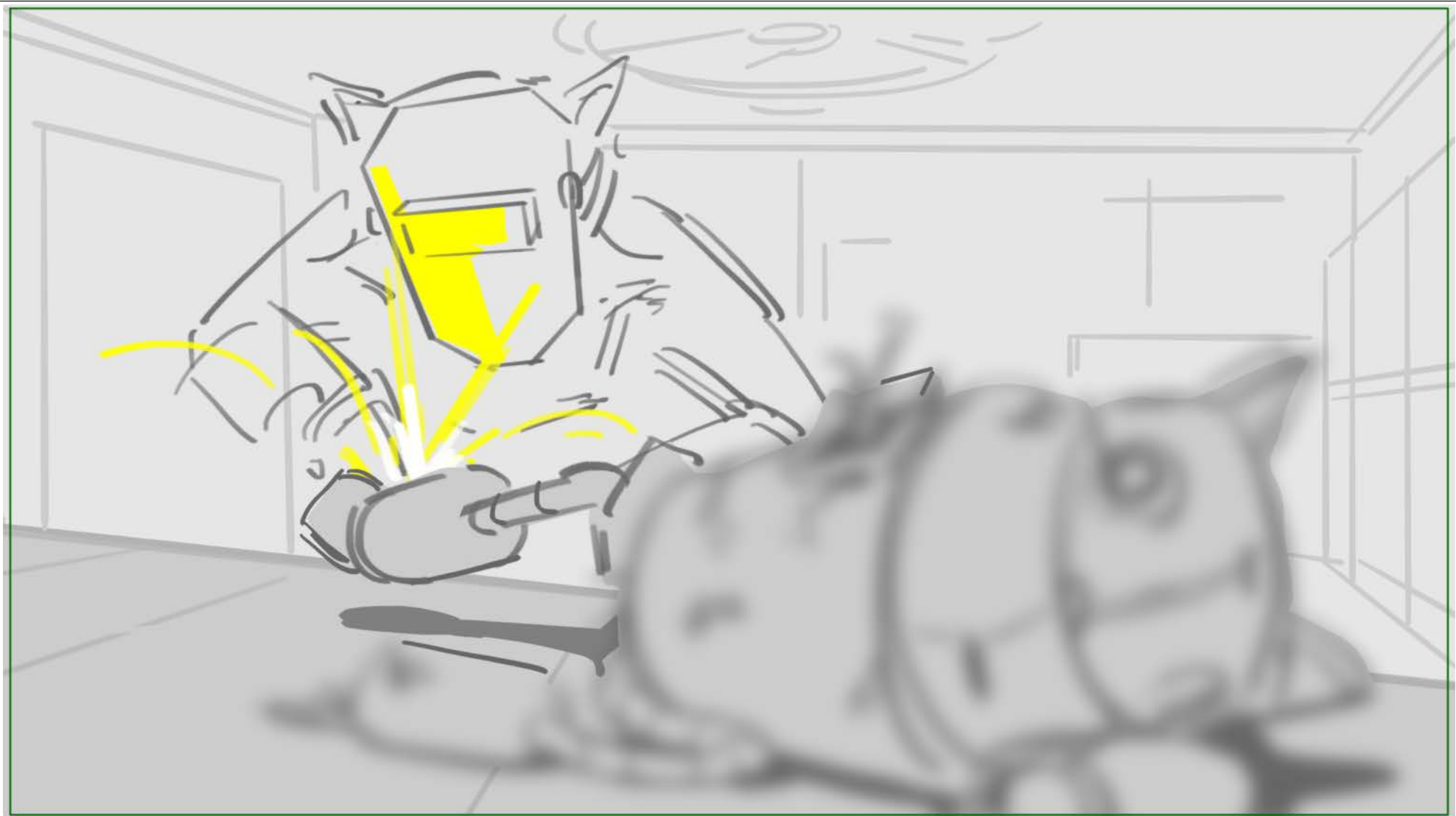

Seq	1		
Scene	Duration	Panel	Duration
20	03:10	4	00:04



Seq	1		
Scene	Duration	Panel	Duration
20	03:10	5	00:04

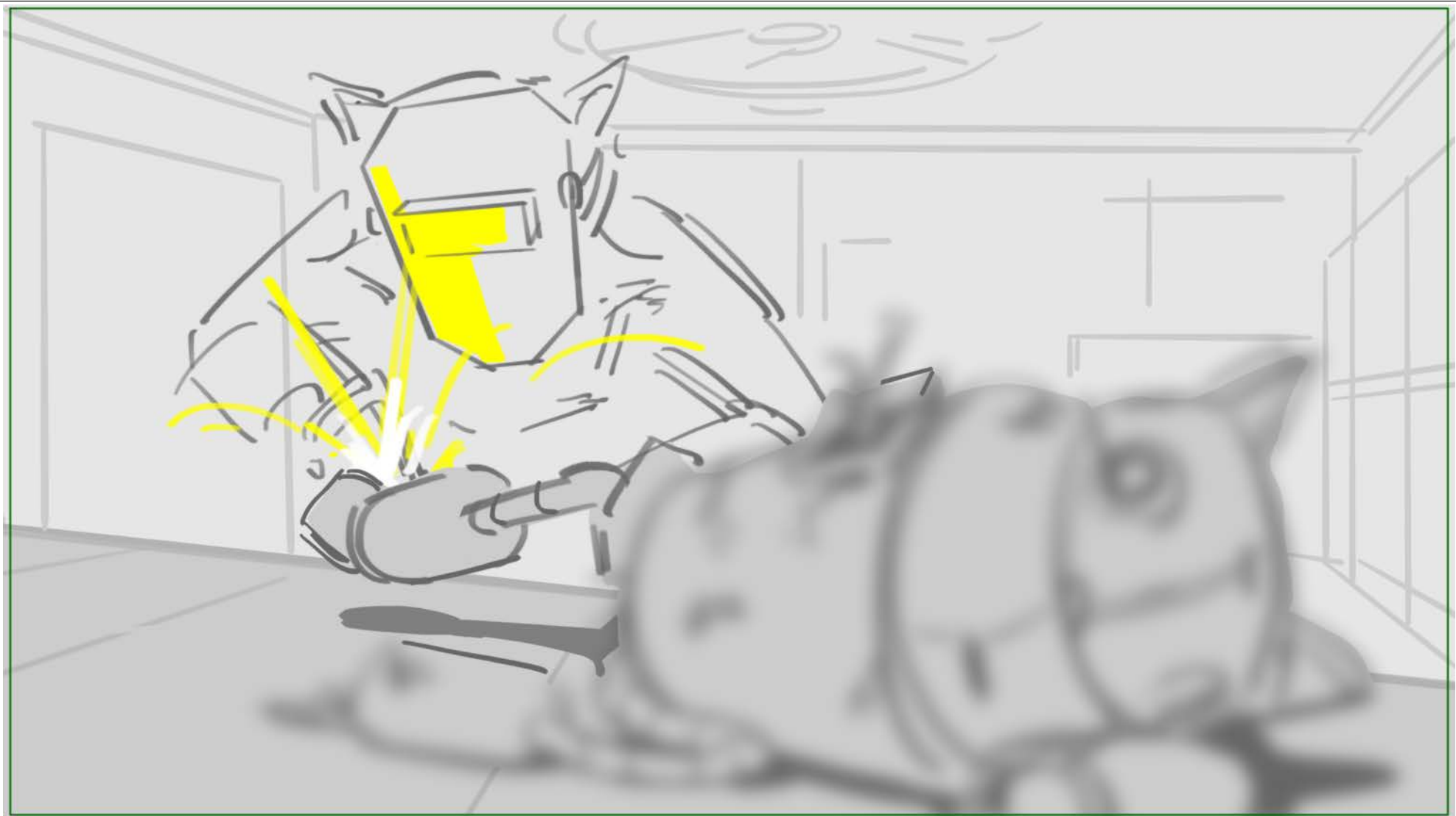

Seq	1		
Scene	Duration	Panel	Duration
20	03:10	6	00:04

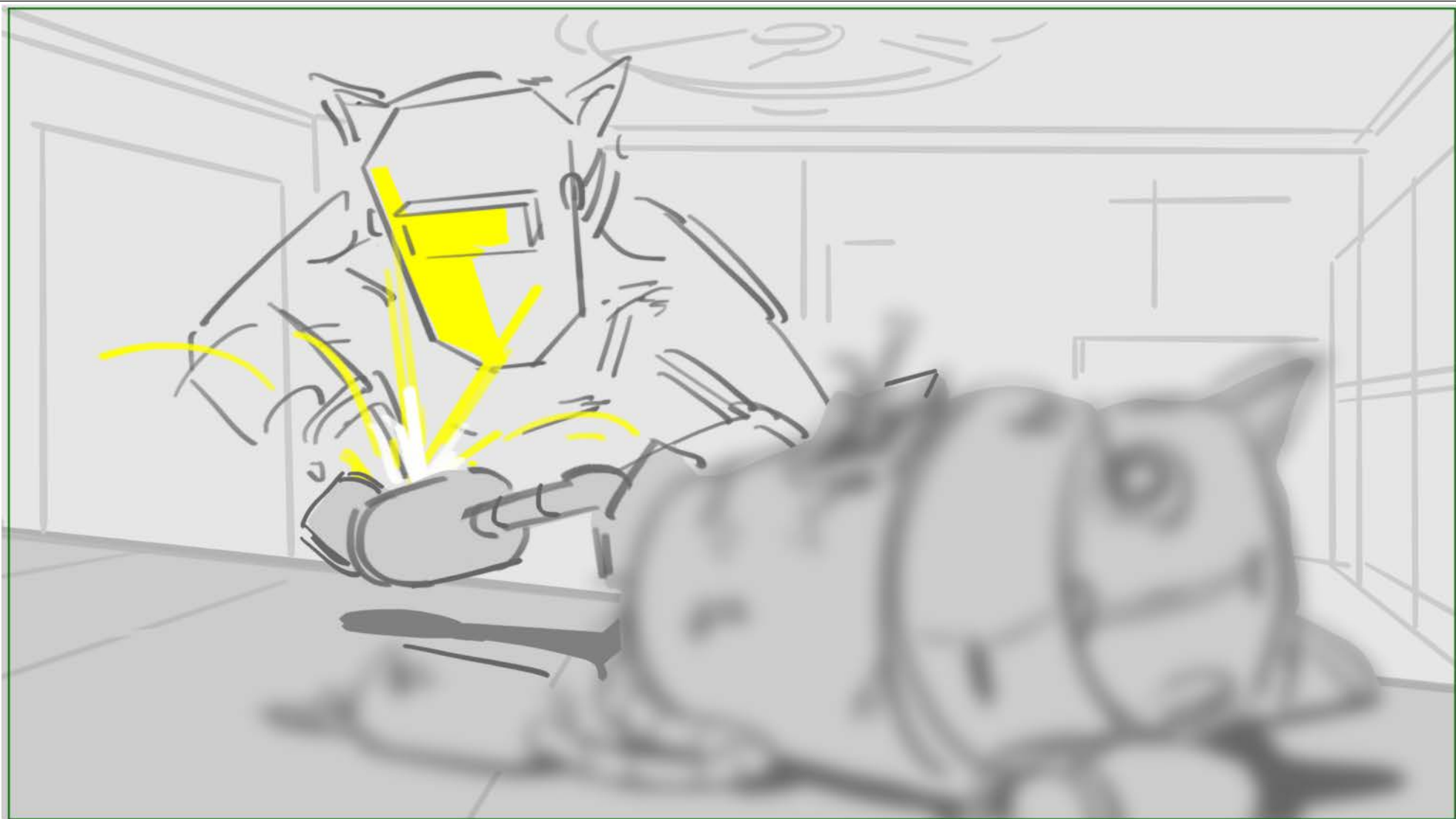

Seq	1		
Scene	Duration	Panel	Duration
20	03:10	7	00:04

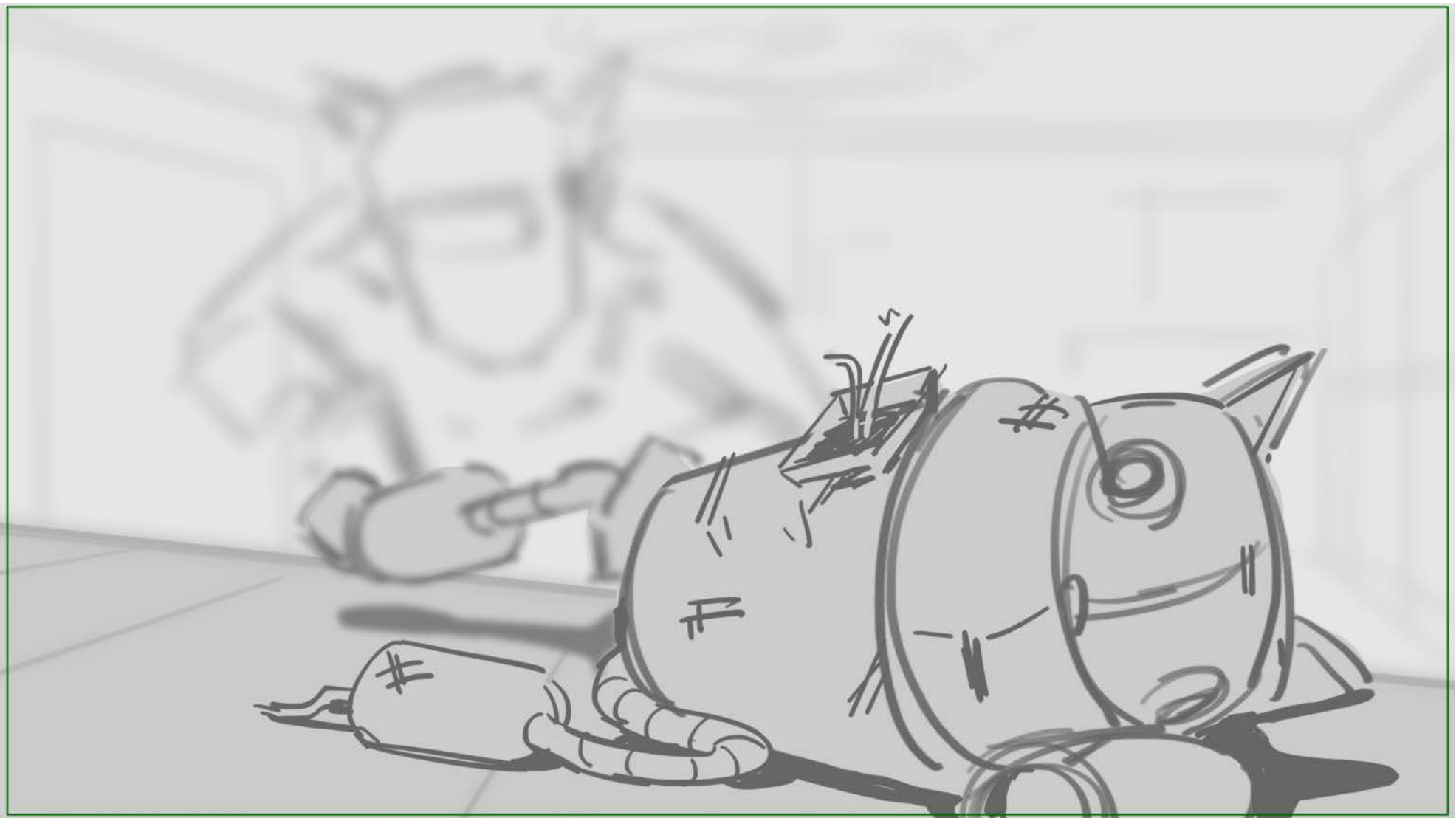

Seq	1		
Scene	Duration	Panel	Duration
20	03:10	8	00:04

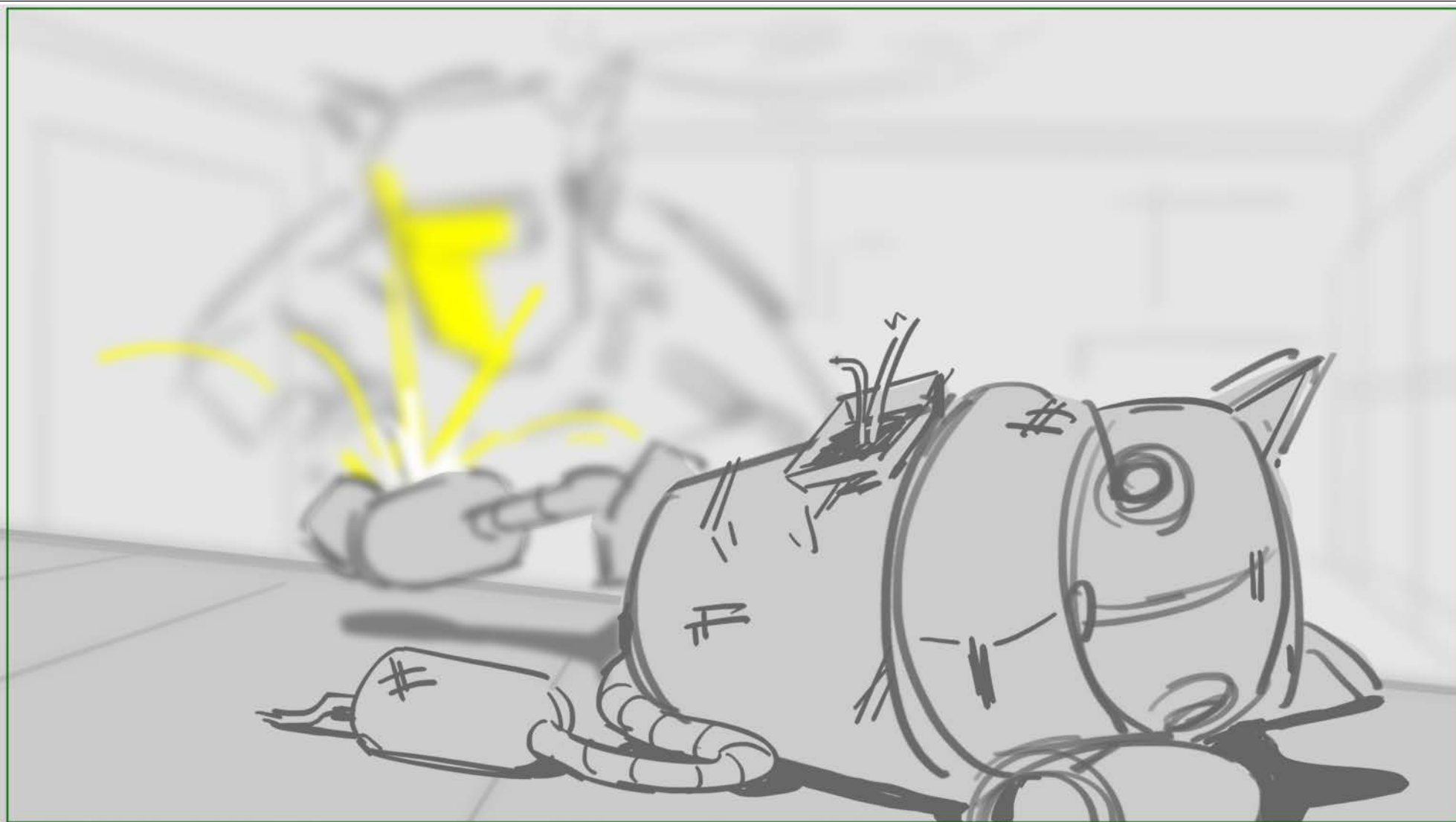

Seq	1		
Scene	Duration	Panel	Duration
20	03:10	9	00:04

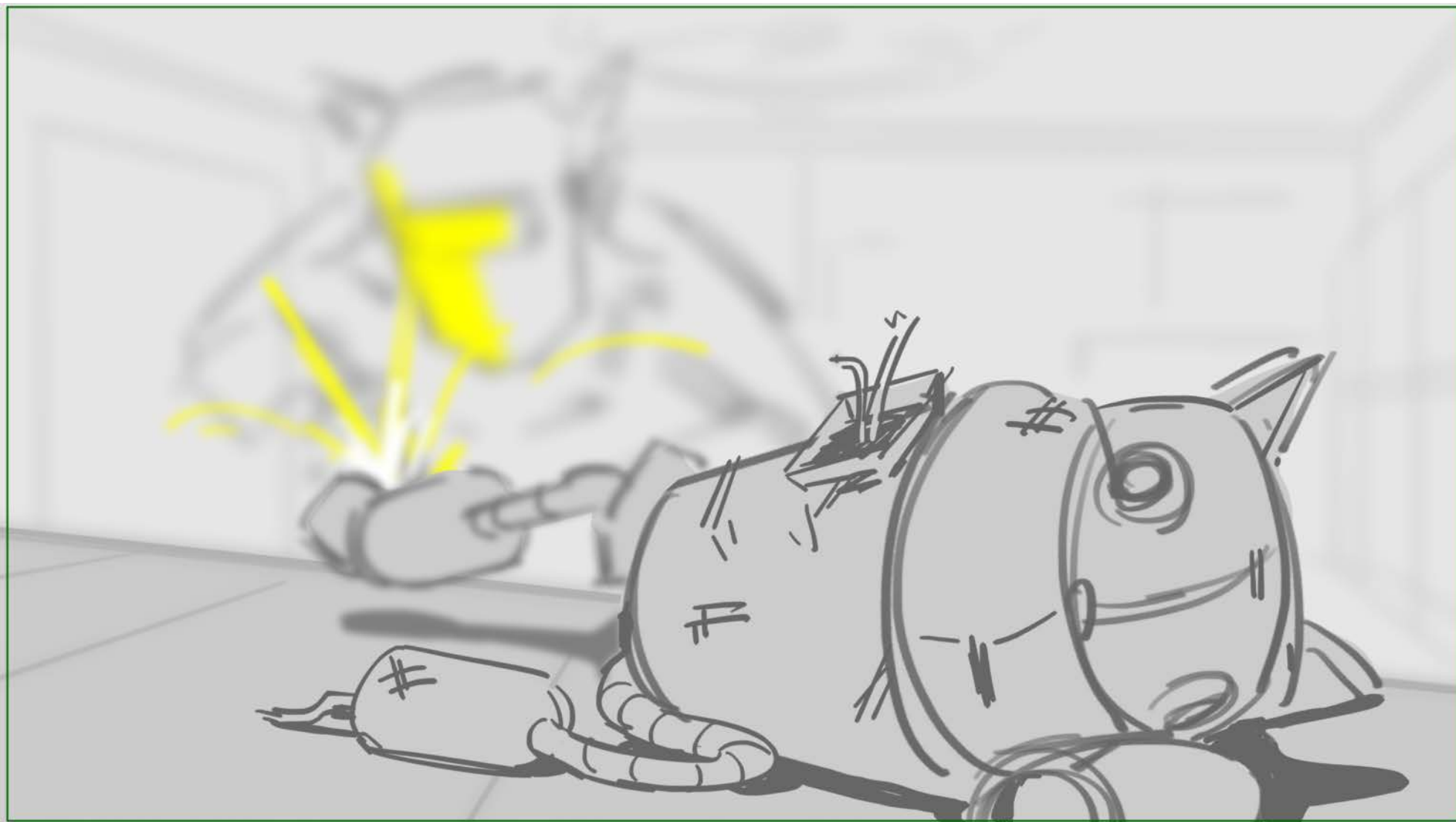

Seq	1		
Scene	Duration	Panel	Duration
20	03:10	10	00:04

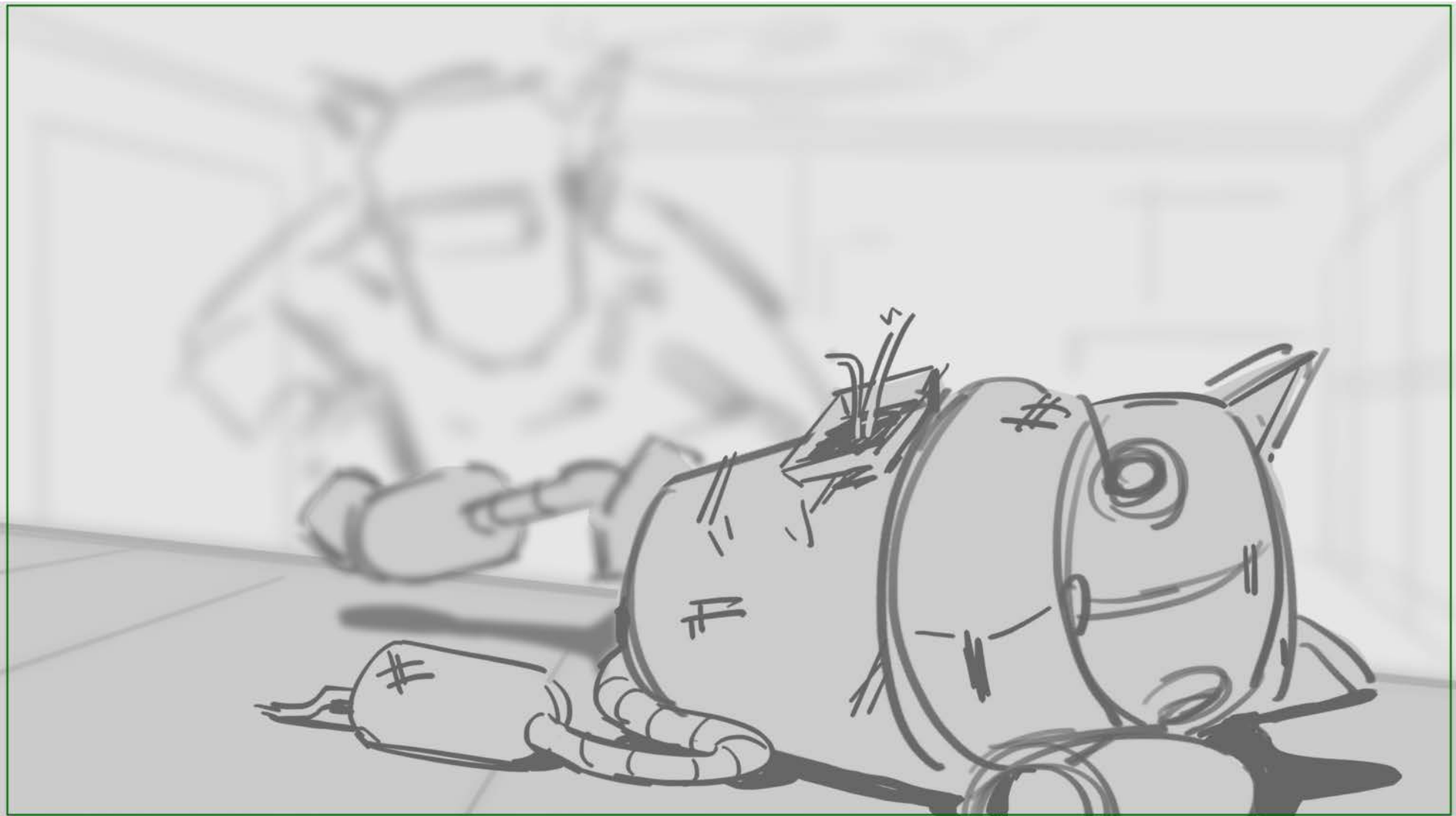

Seq	1		
Scene	Duration	Panel	Duration
20	03:10	11	00:04

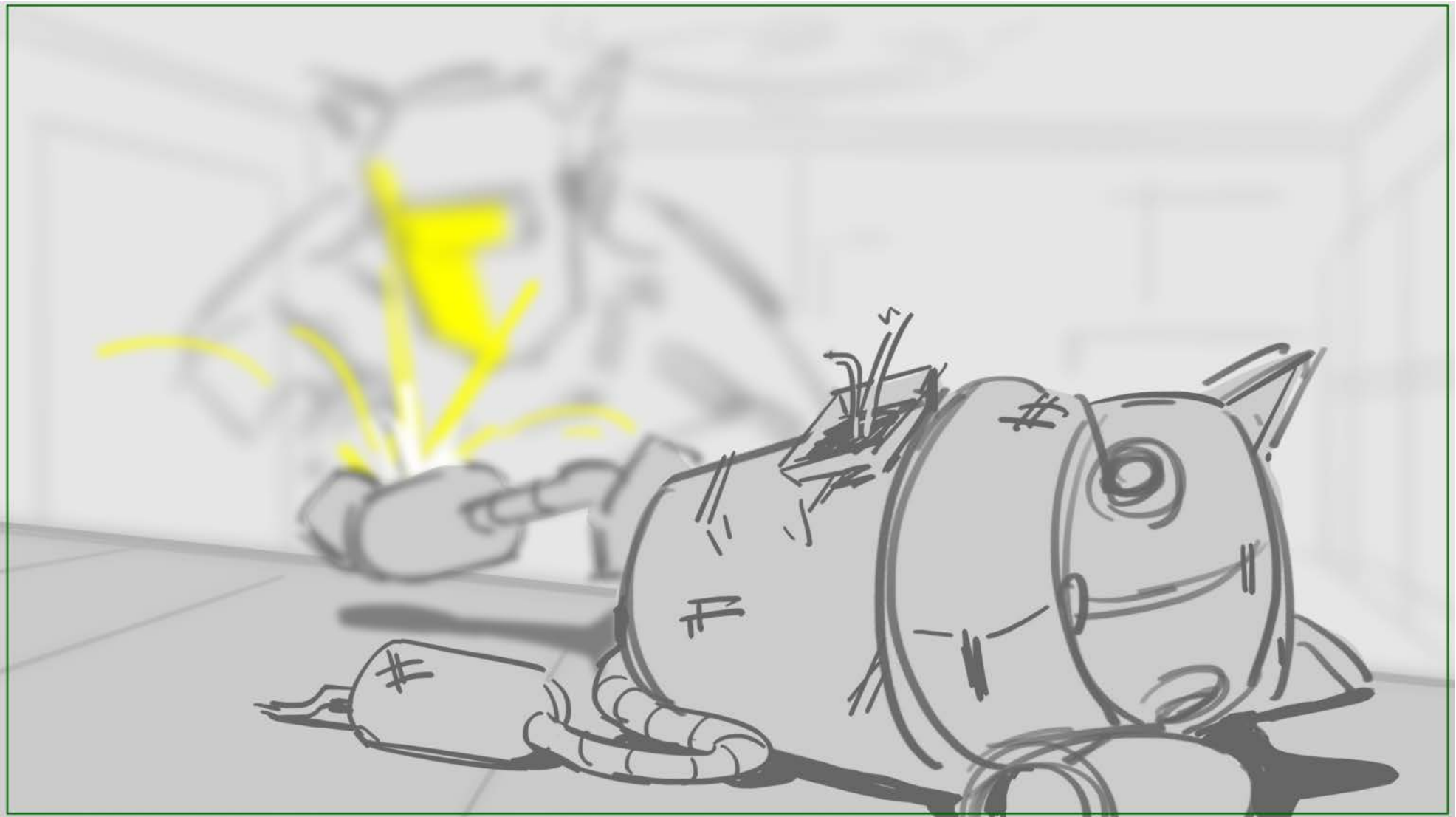

Seq	1		
Scene	Duration	Panel	Duration
20	03:10	12	00:04

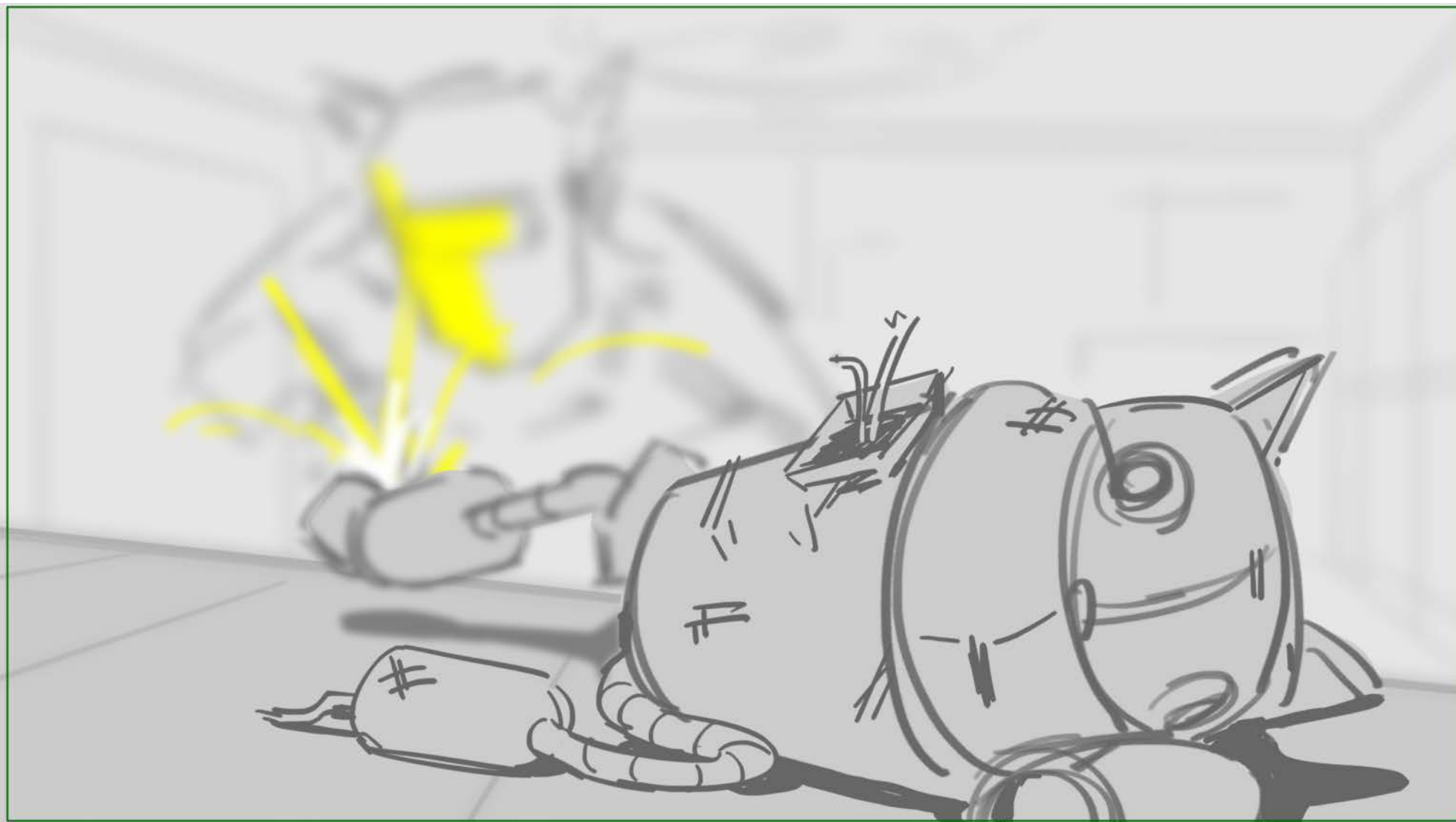

Seq	1		
Scene	Duration	Panel	Duration
20	03:10	13	00:04

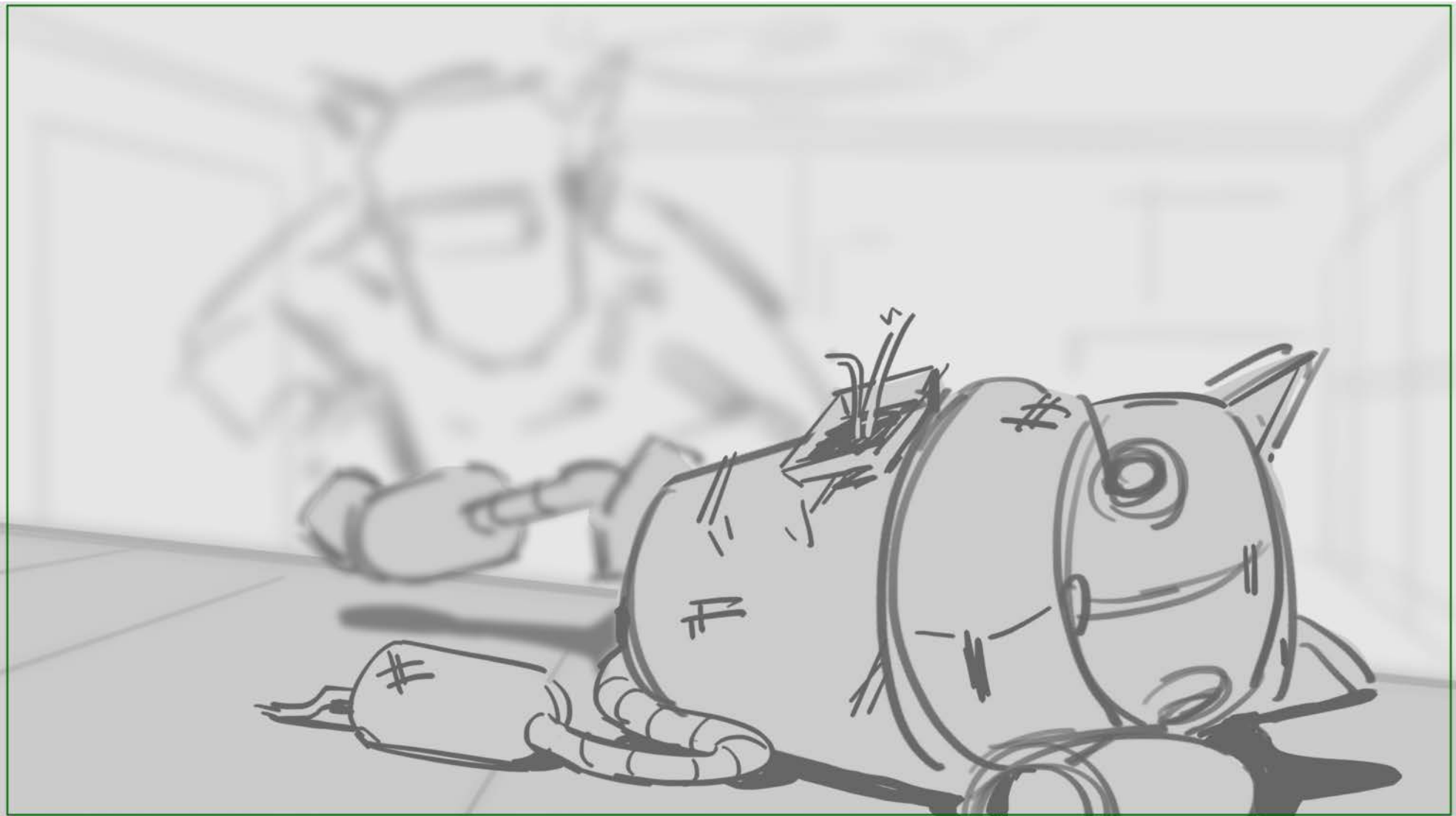

Seq	1		
Scene	Duration	Panel	Duration
20	03:10	14	00:04

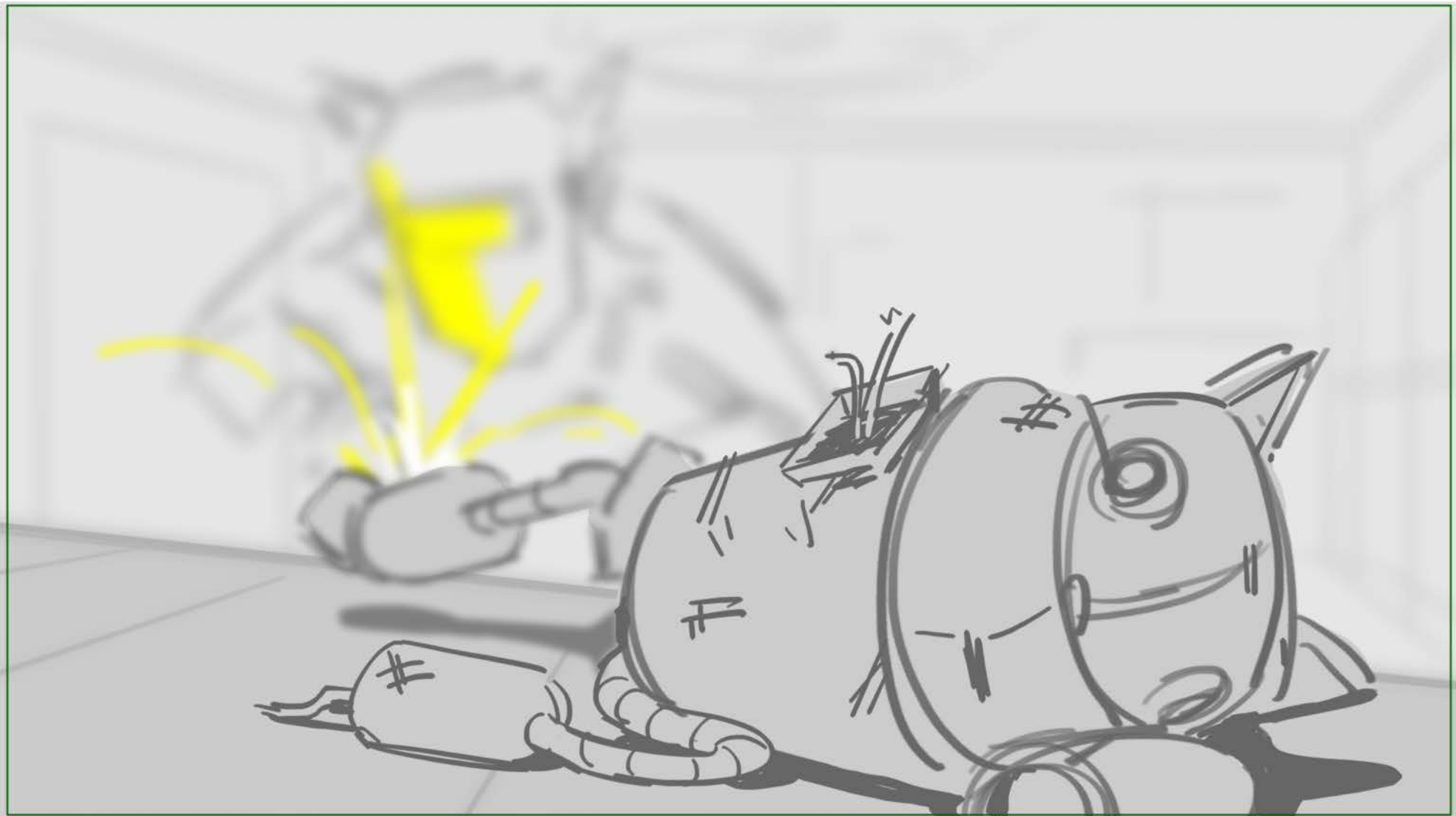

Seq	1		
Scene	Duration	Panel	Duration
20	03:10	15	00:04

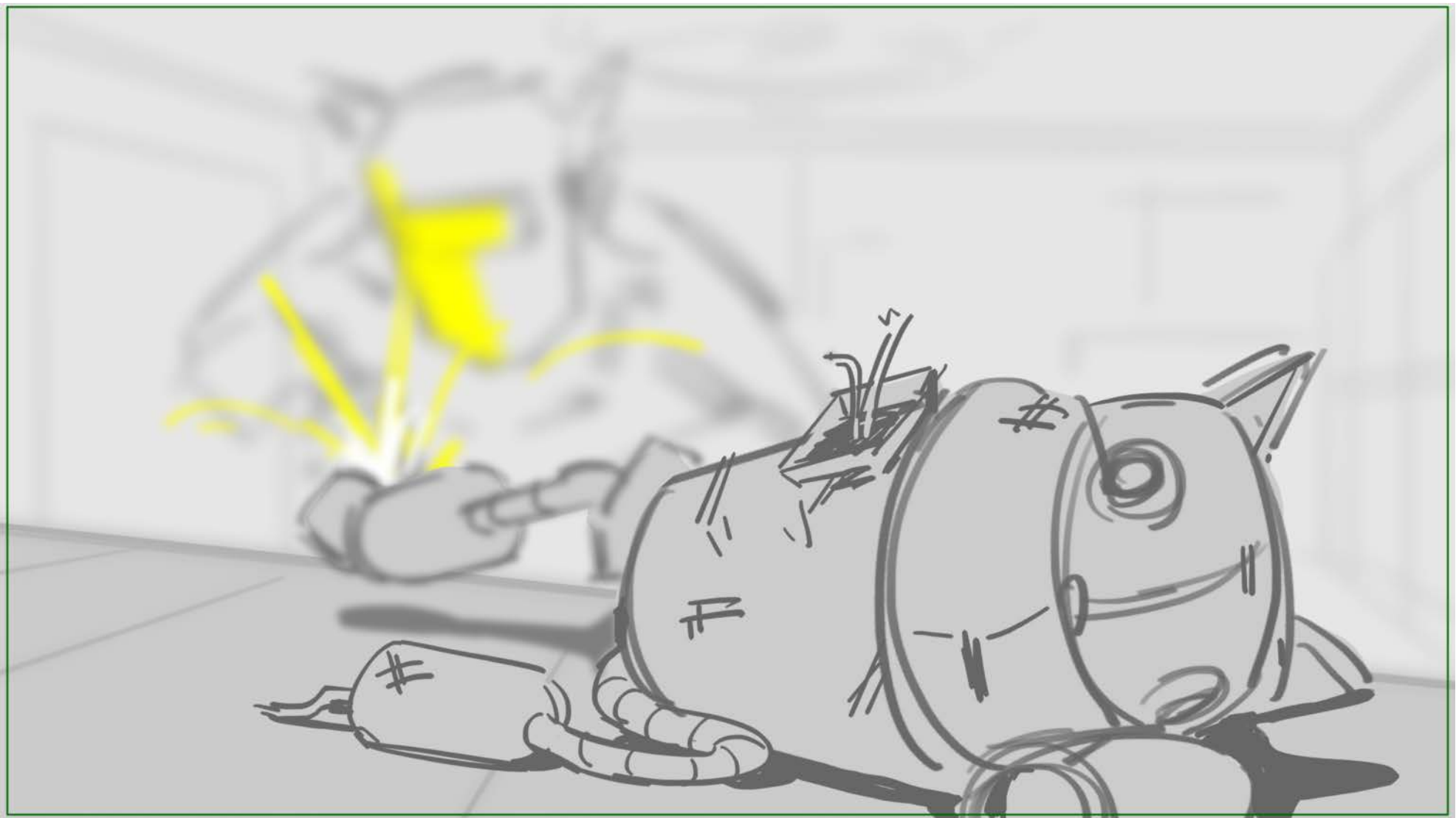

Seq	1		
Scene	Duration	Panel	Duration
20	03:10	16	00:14

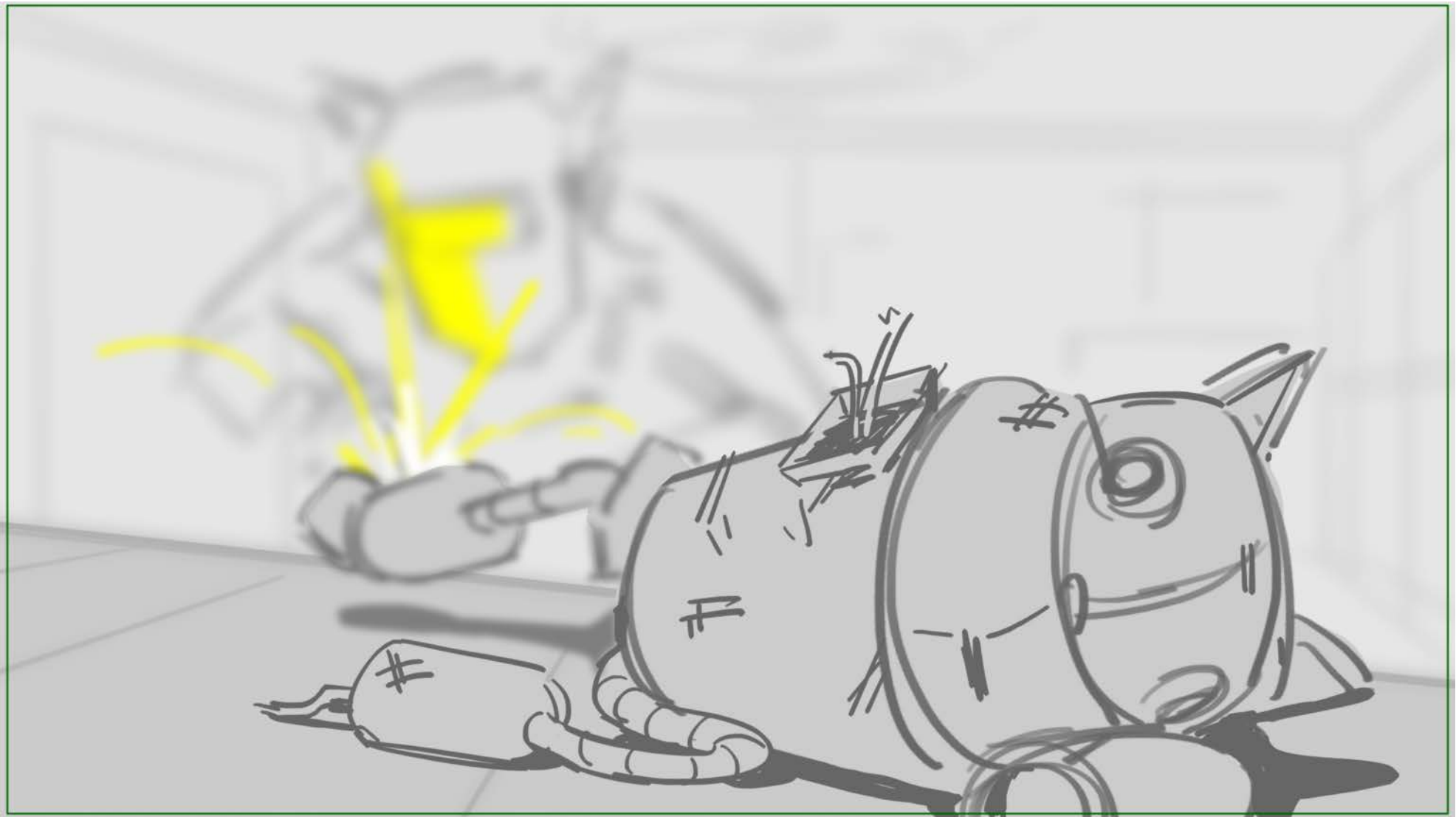

Seq	1		
Scene	Duration	Panel	Duration
21	01:05	1	01:05



Seq	1		
Scene	Duration	Panel	Duration
22	00:22	1	00:22



Seq	1		
Scene	Duration	Panel	Duration
23a	01:19	1	01:19



--	--	--	--

Seq	1		
Scene	Duration	Panel	Duration
23b	00:21	1	00:21



Seq	1		
Scene	Duration	Panel	Duration
23c	00:18	1	00:18



Seq	1		
Scene	Duration	Panel	Duration
23d	00:16	1	00:16

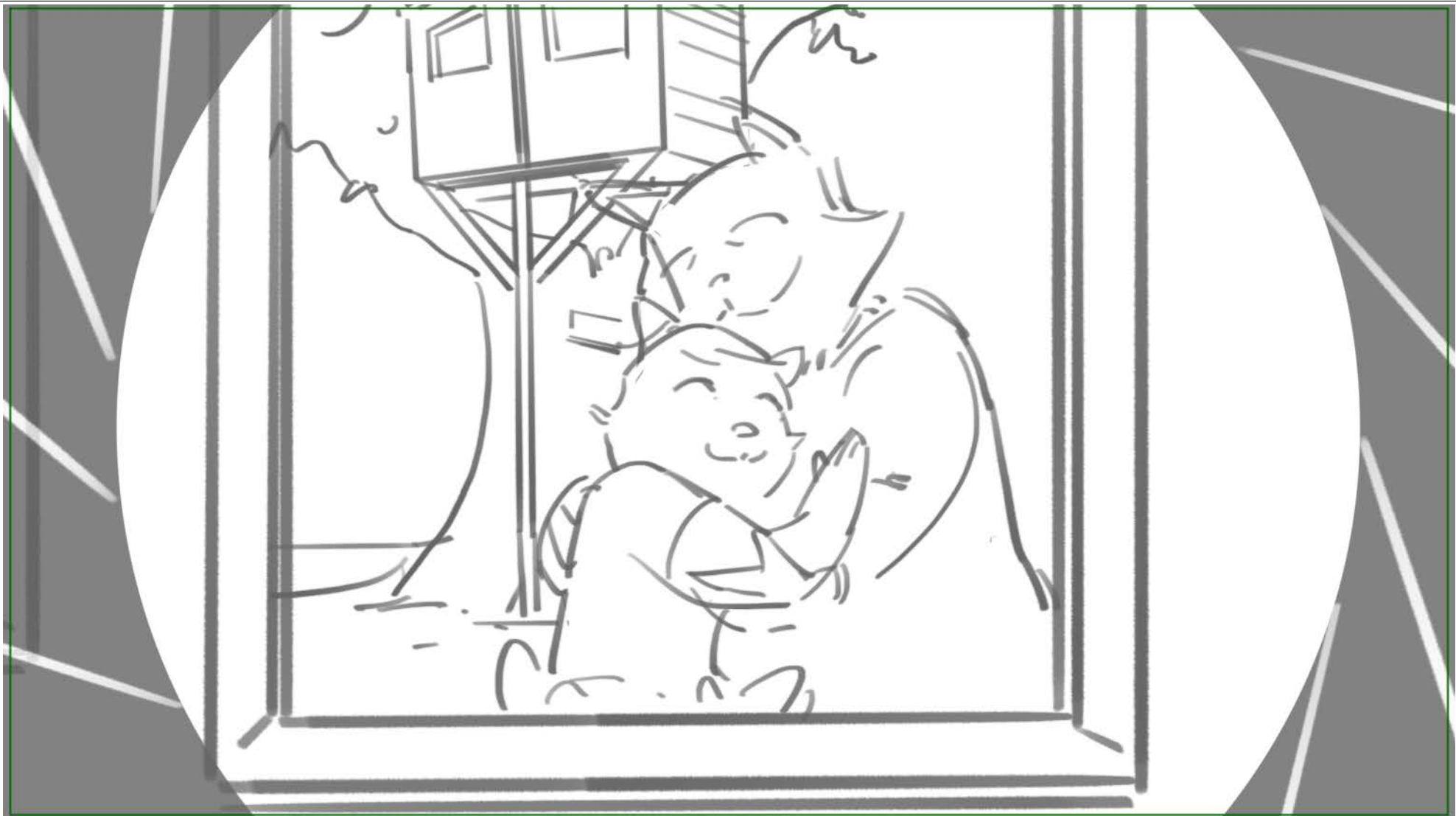

Seq	1		
Scene	Duration	Panel	Duration
23e	00:09	1	00:09

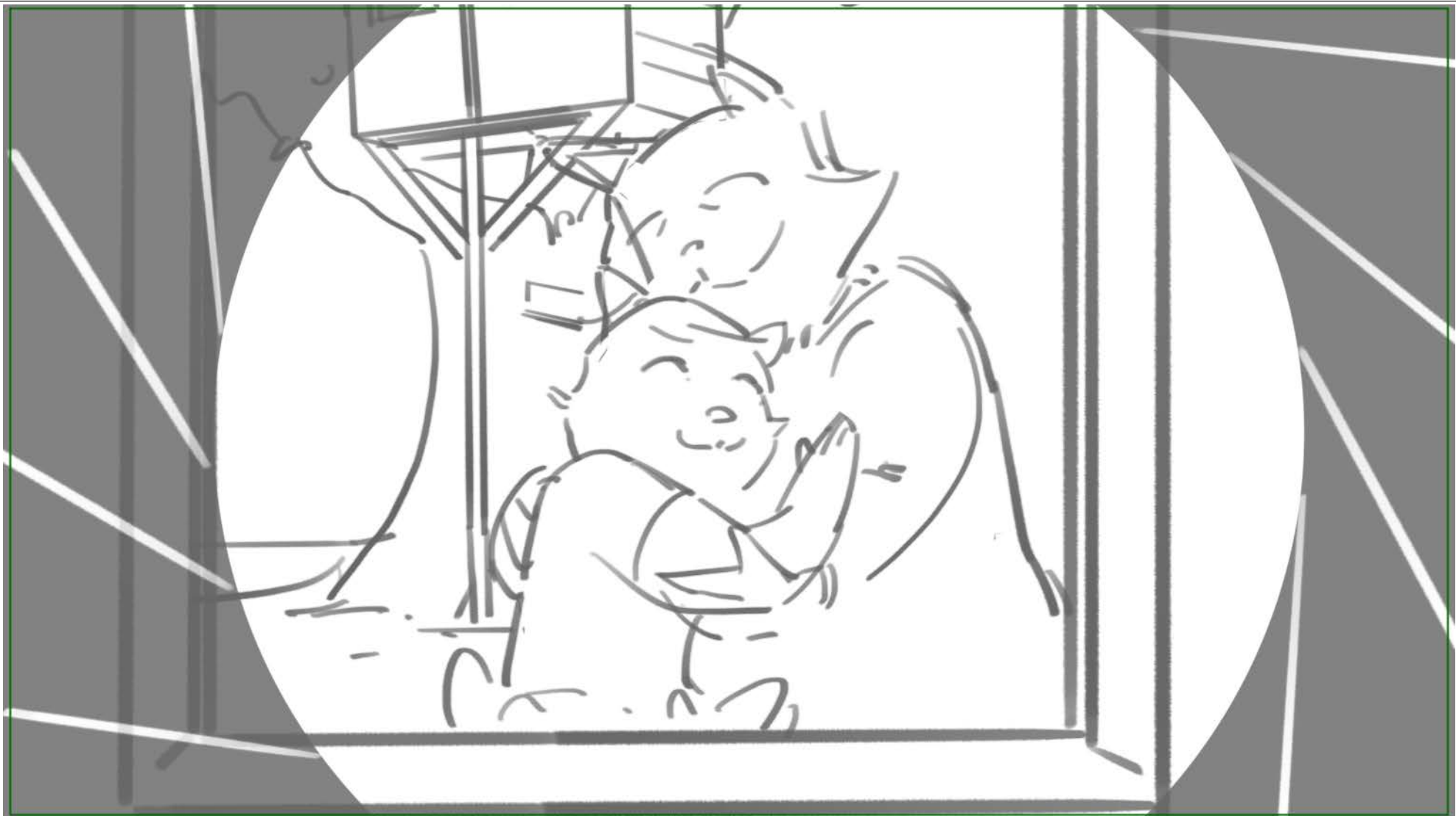

Seq	1		
Scene	Duration	Panel	Duration
24	02:15	1	02:15

Dia

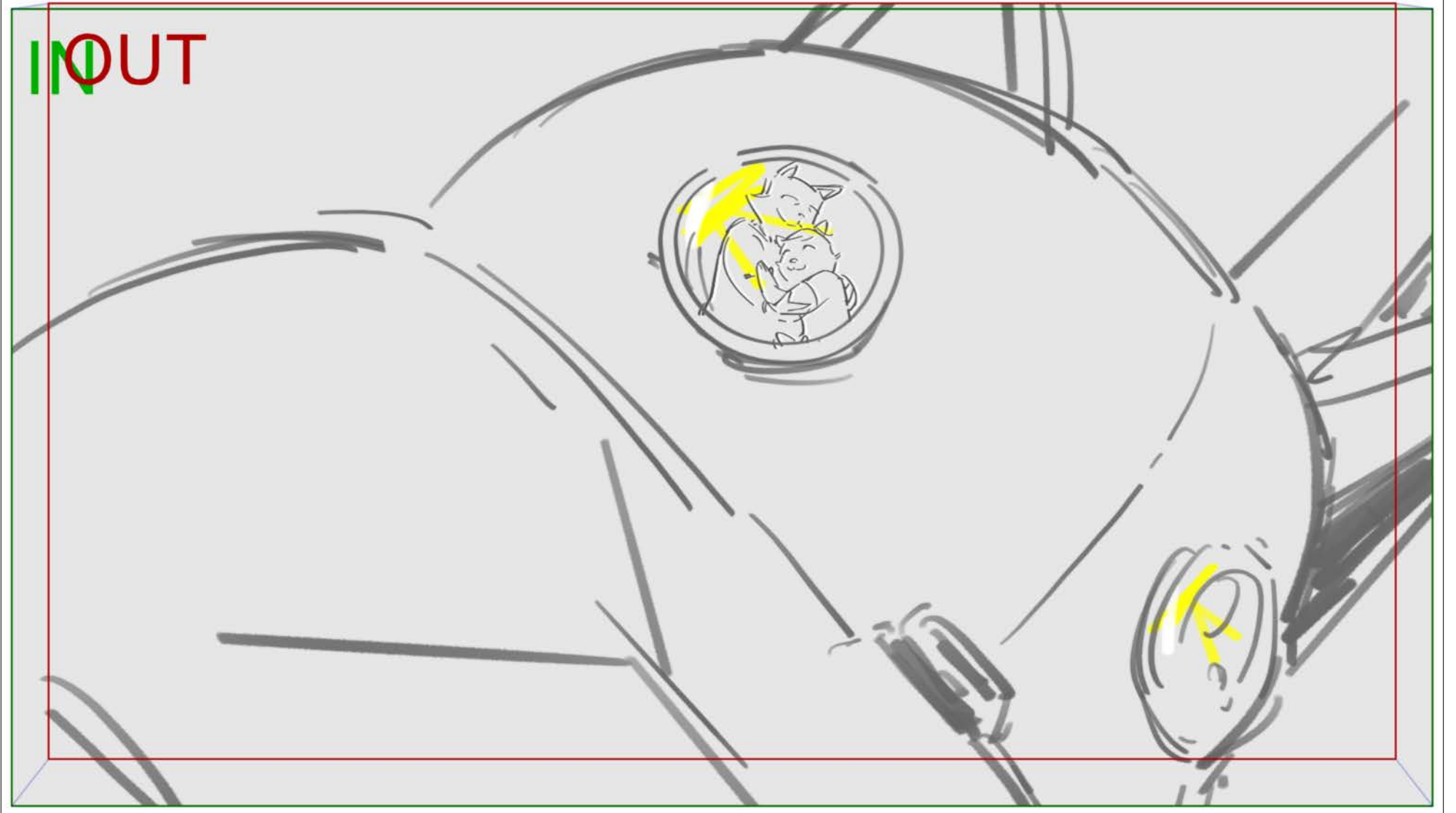

Seq	1		
Scene	Duration	Panel	Duration
25A	03:07	1	00:22

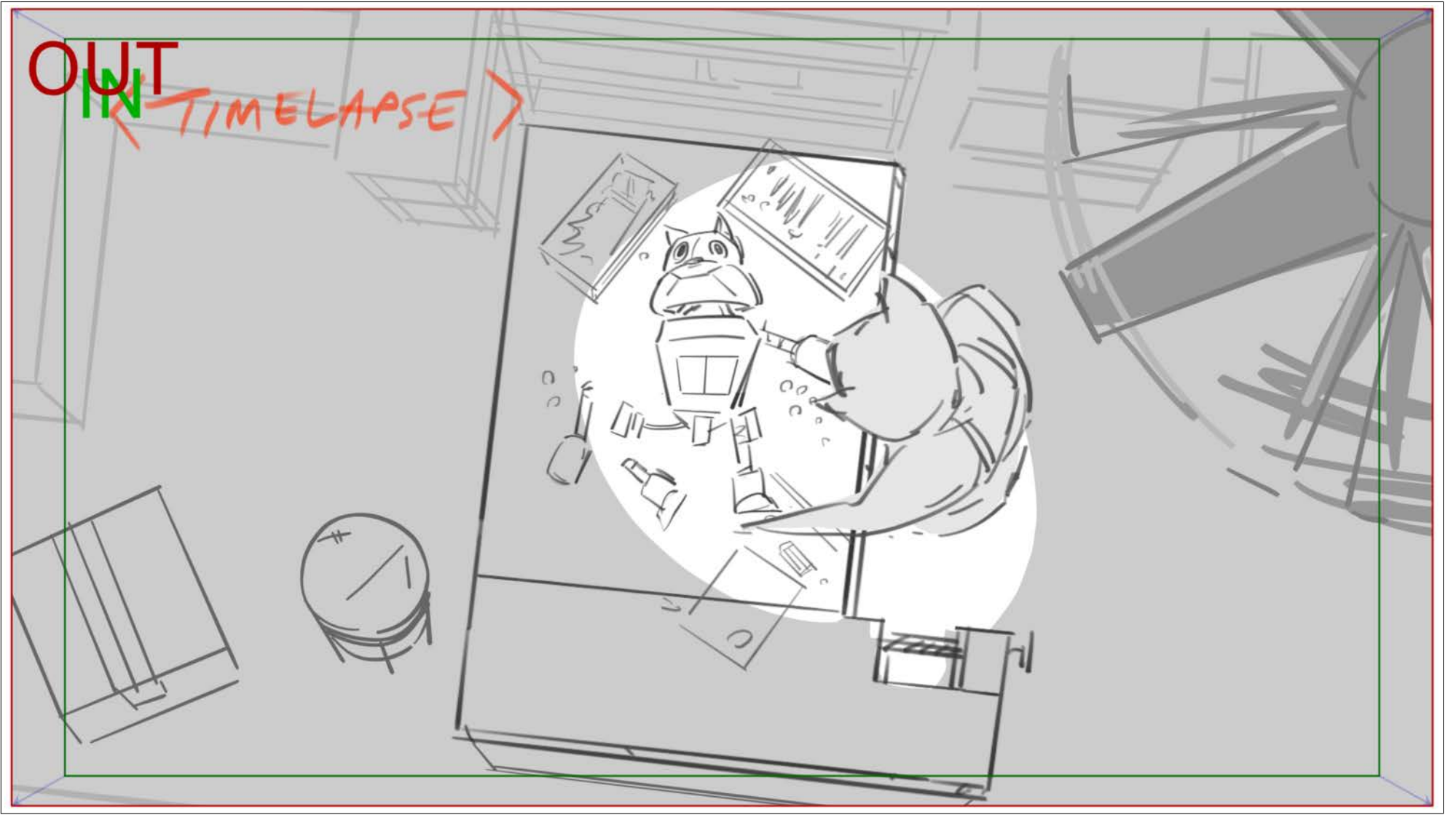

Seq	1		
Scene	Duration	Panel	Duration
25A	03:07	2	00:22

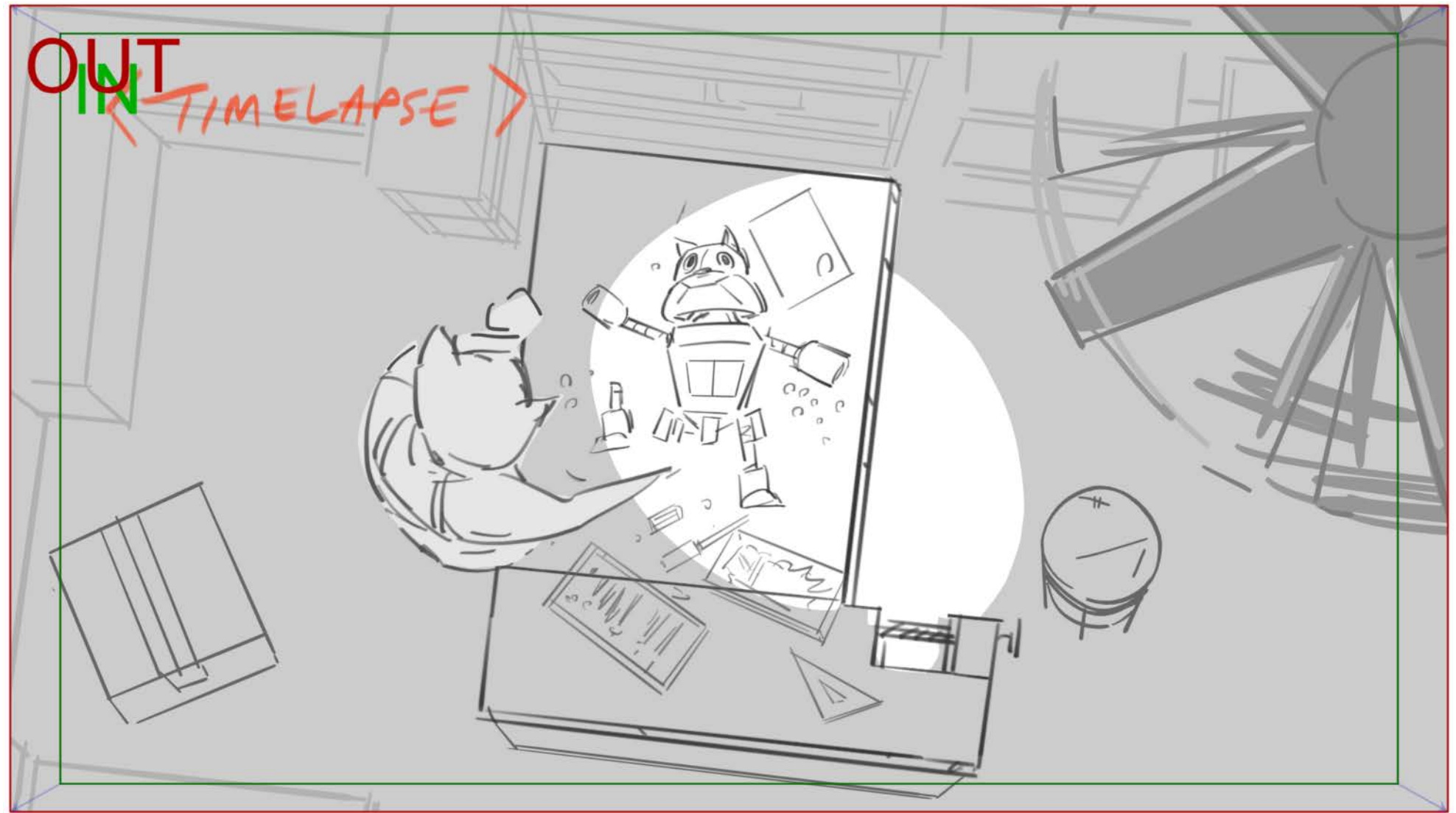

Seq	1		
Scene	Duration	Panel	Duration
25A	03:07	3	01:11

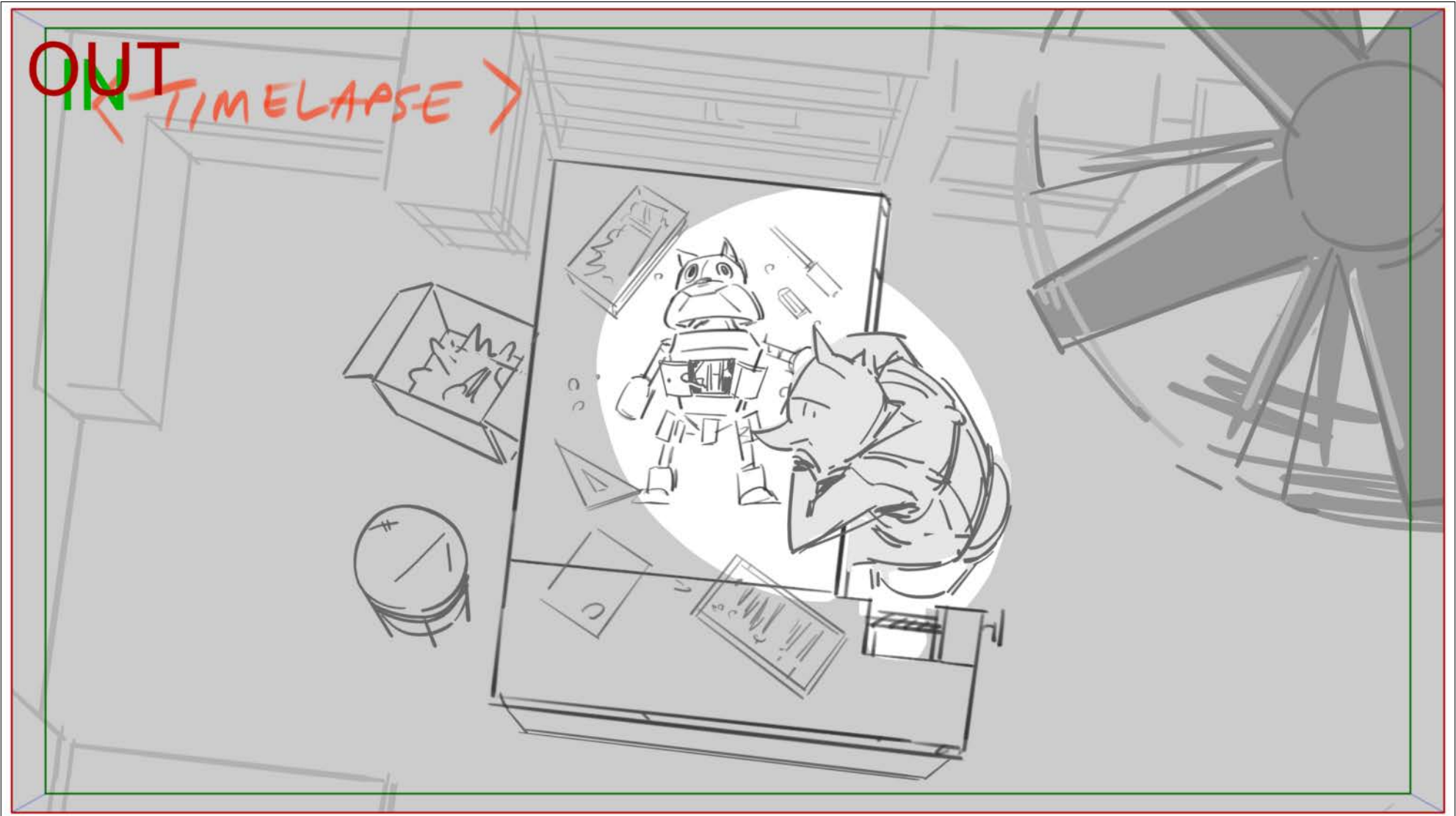

Seq	1		
Scene	Duration	Panel	Duration
26	01:23	1	01:23



Seq	1		
Scene	Duration	Panel	Duration
27	01:14	1	01:14

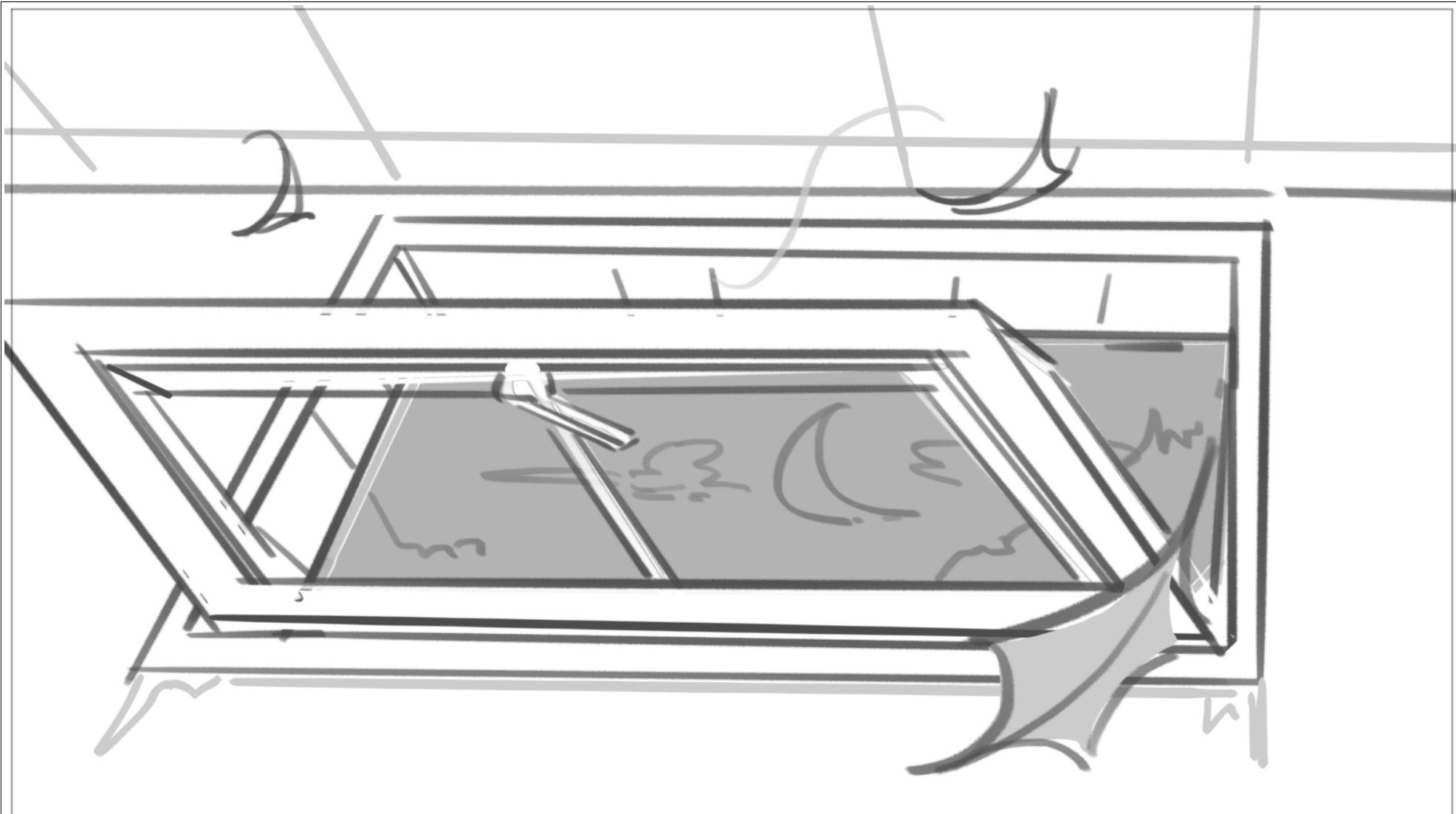

Seq	1		
Scene	Duration	Panel	Duration
28	02:11	1	01:00

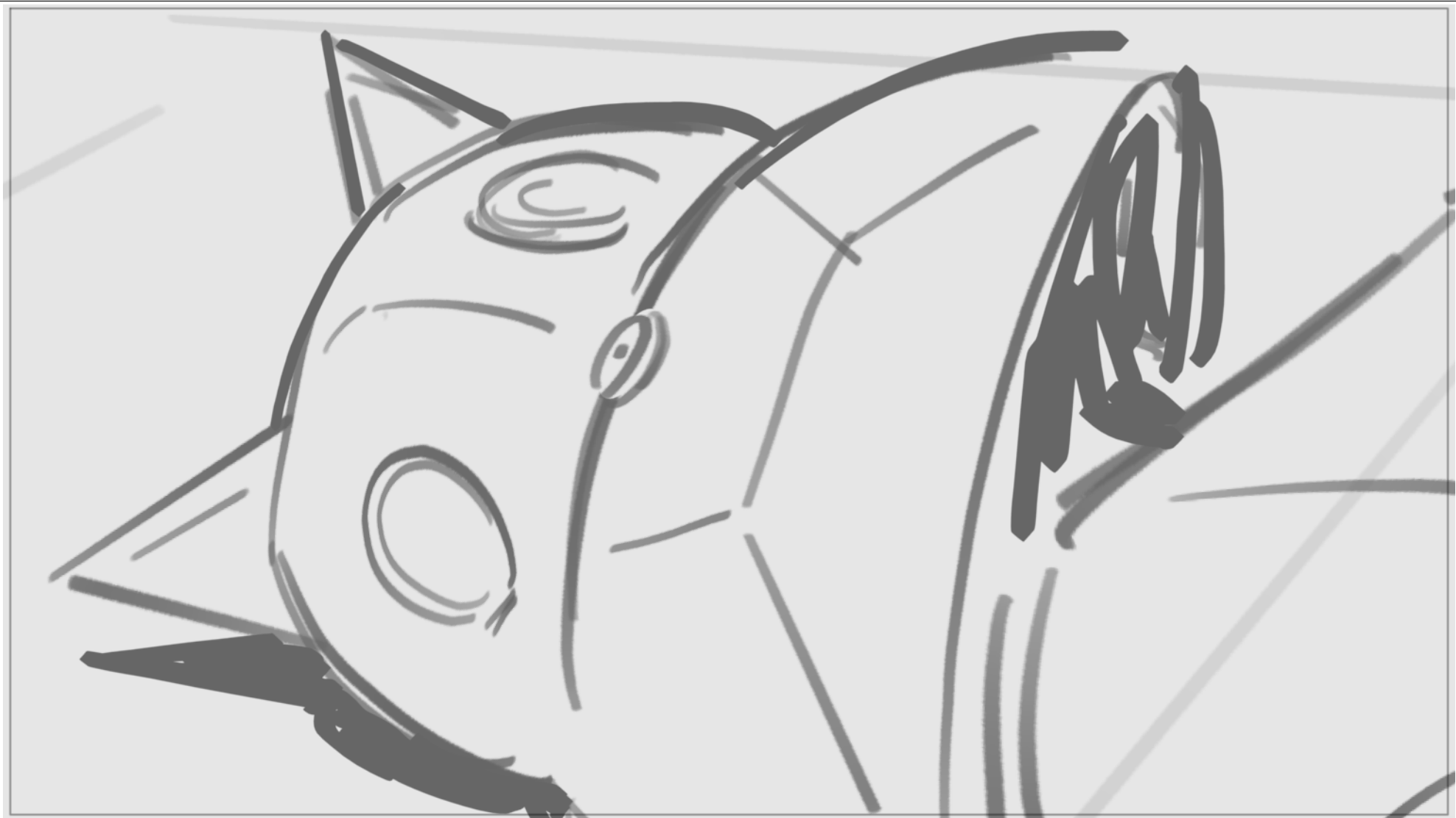

Seq	1		
Scene	Duration	Panel	Duration
28	02:11	2	00:04

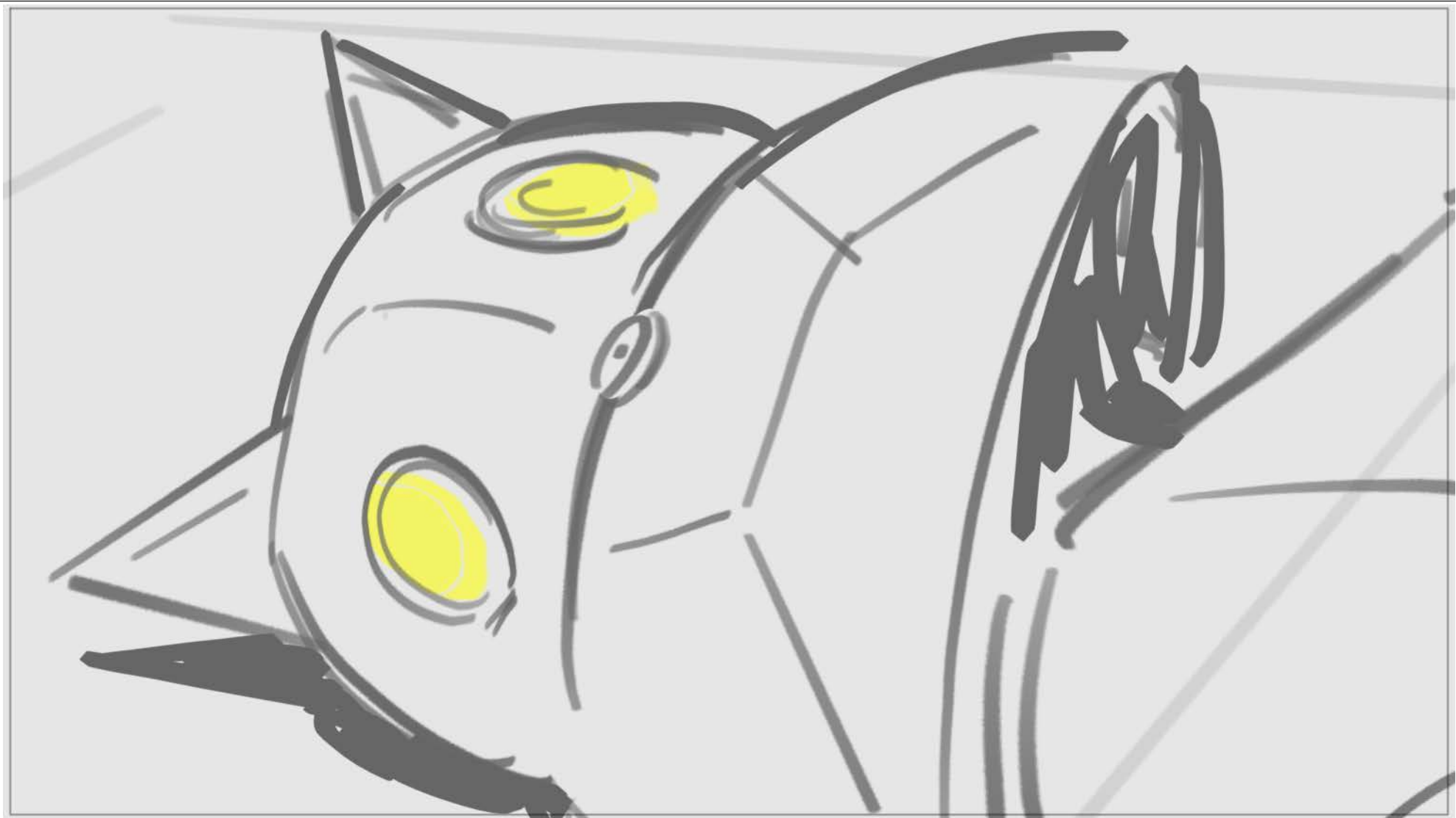

Seq	1		
Scene	Duration	Panel	Duration
28	02:11	3	00:02

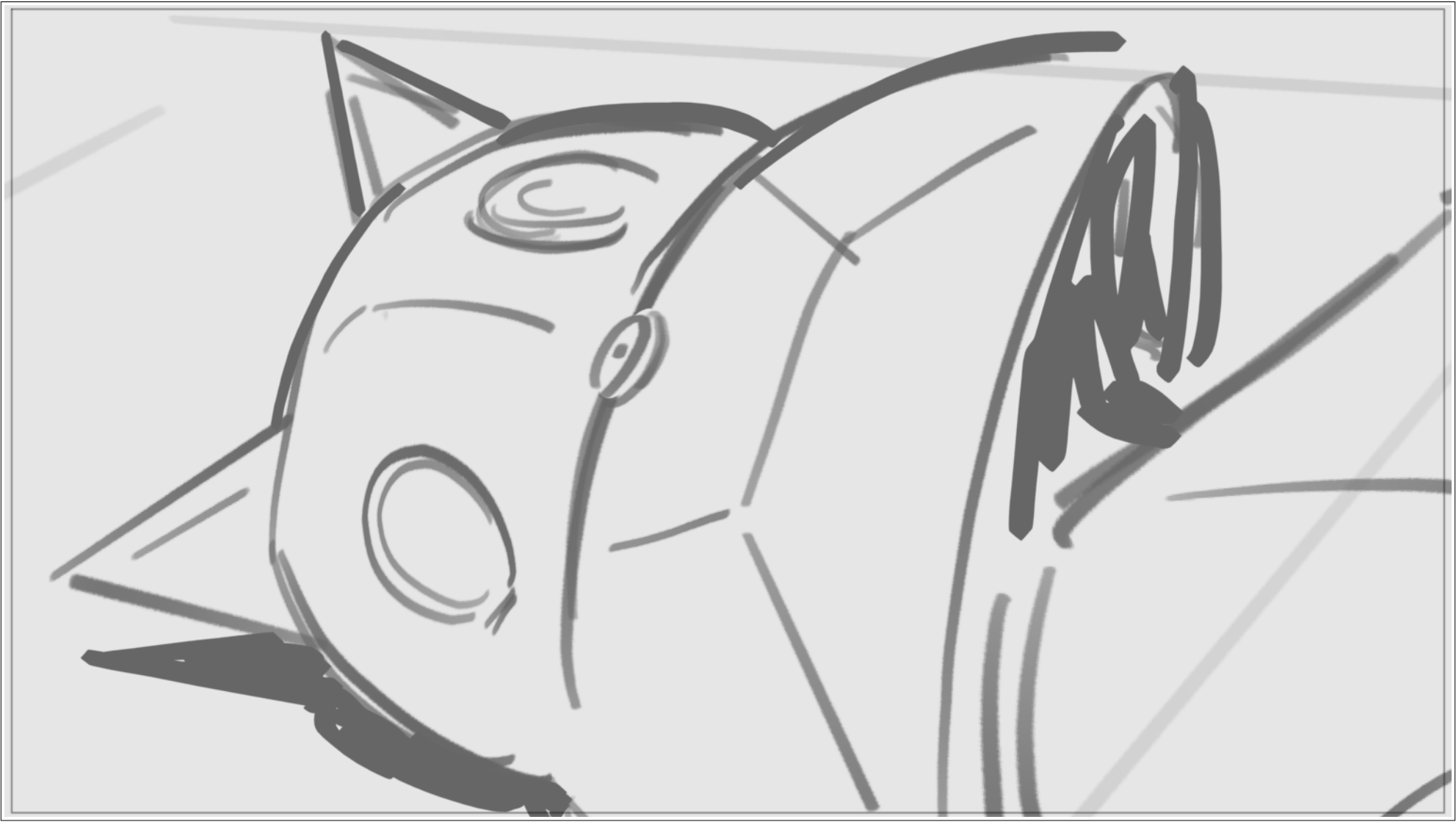

Seq	1		
Scene	Duration	Panel	Duration
28	02:11	4	00:06

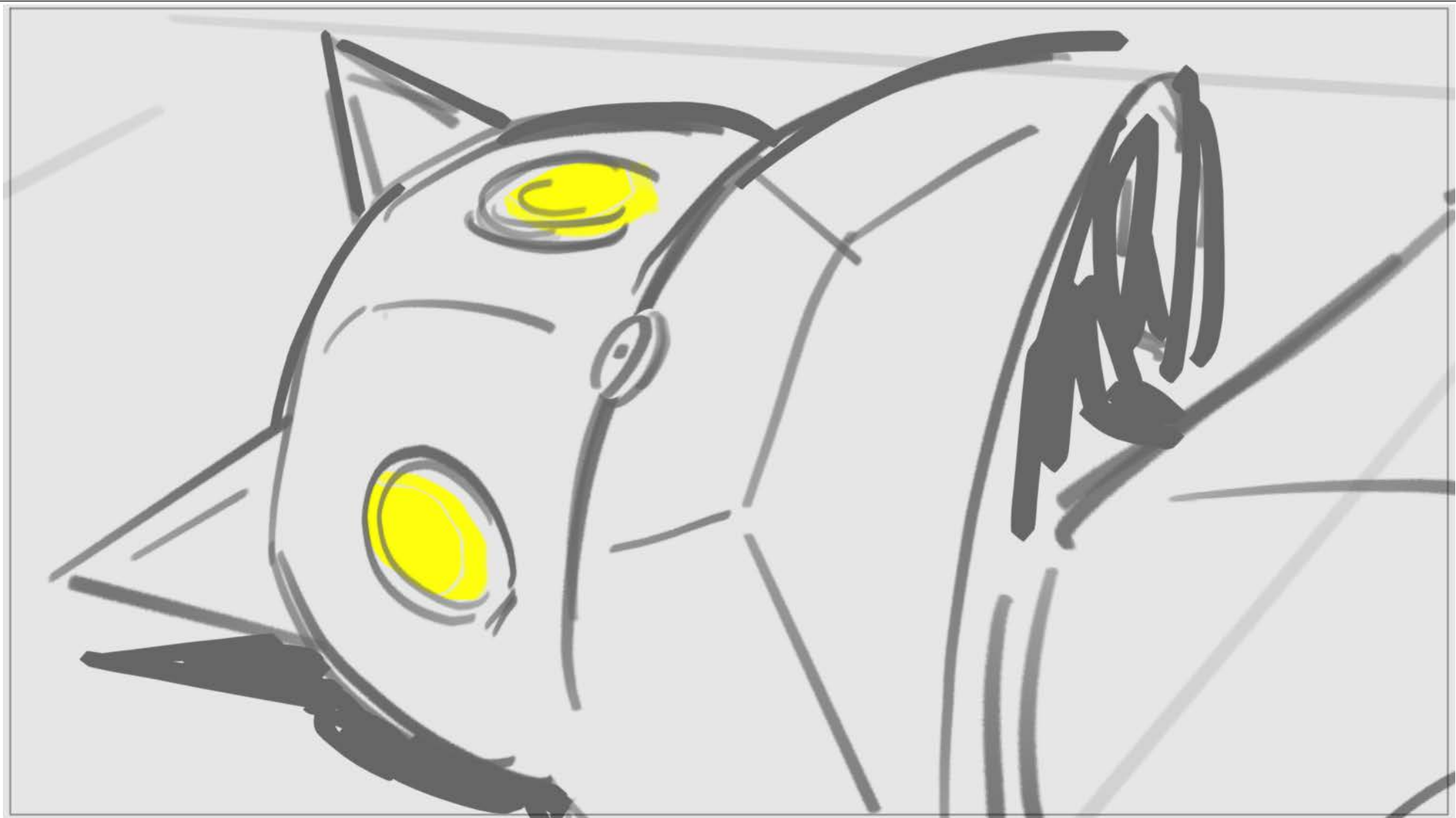

Seq	1		
Scene	Duration	Panel	Duration
28	02:11	5	00:08

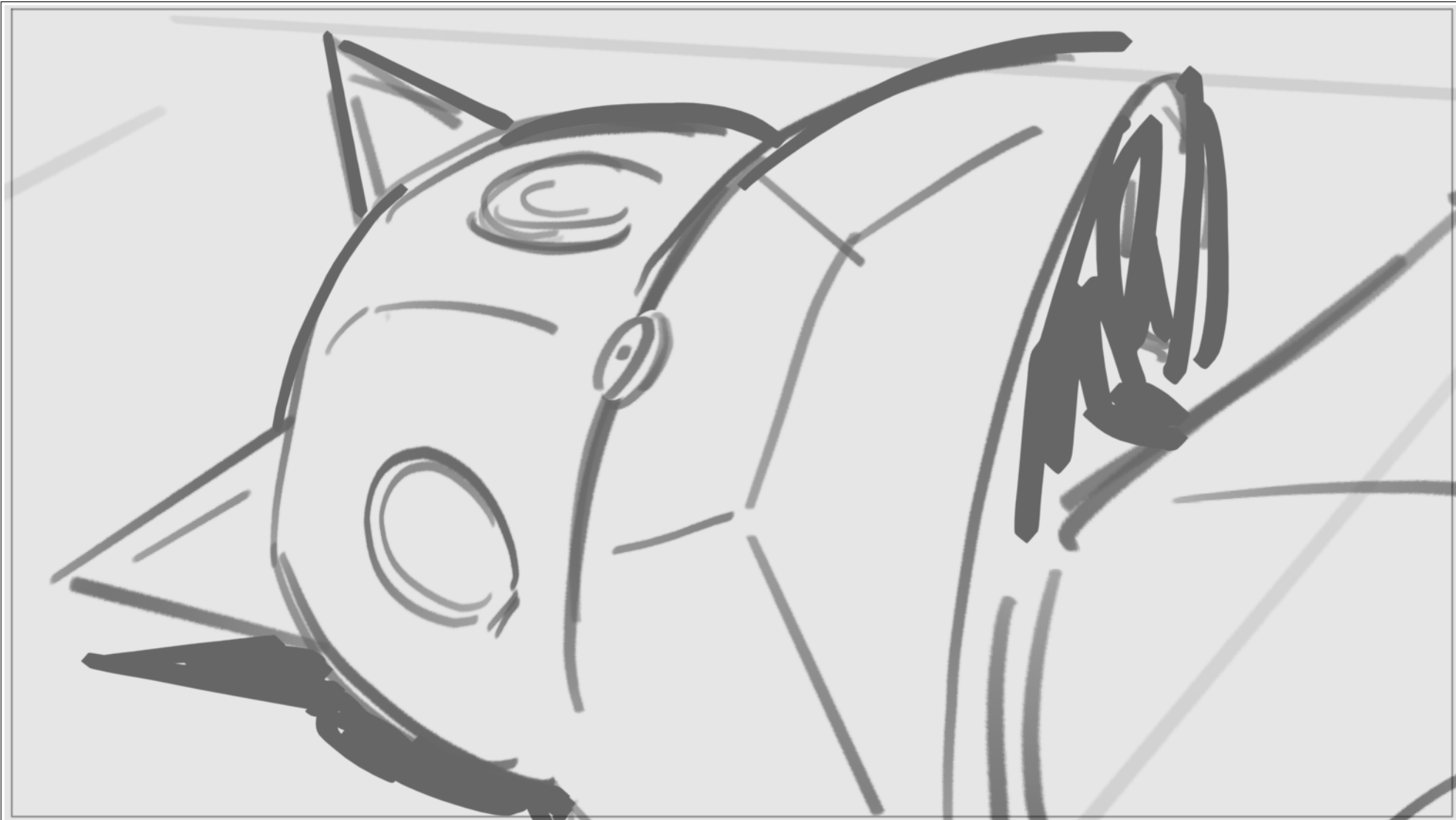

Dia

Seq	1		
Scene	Duration	Panel	Duration
28	02:11	6	00:15

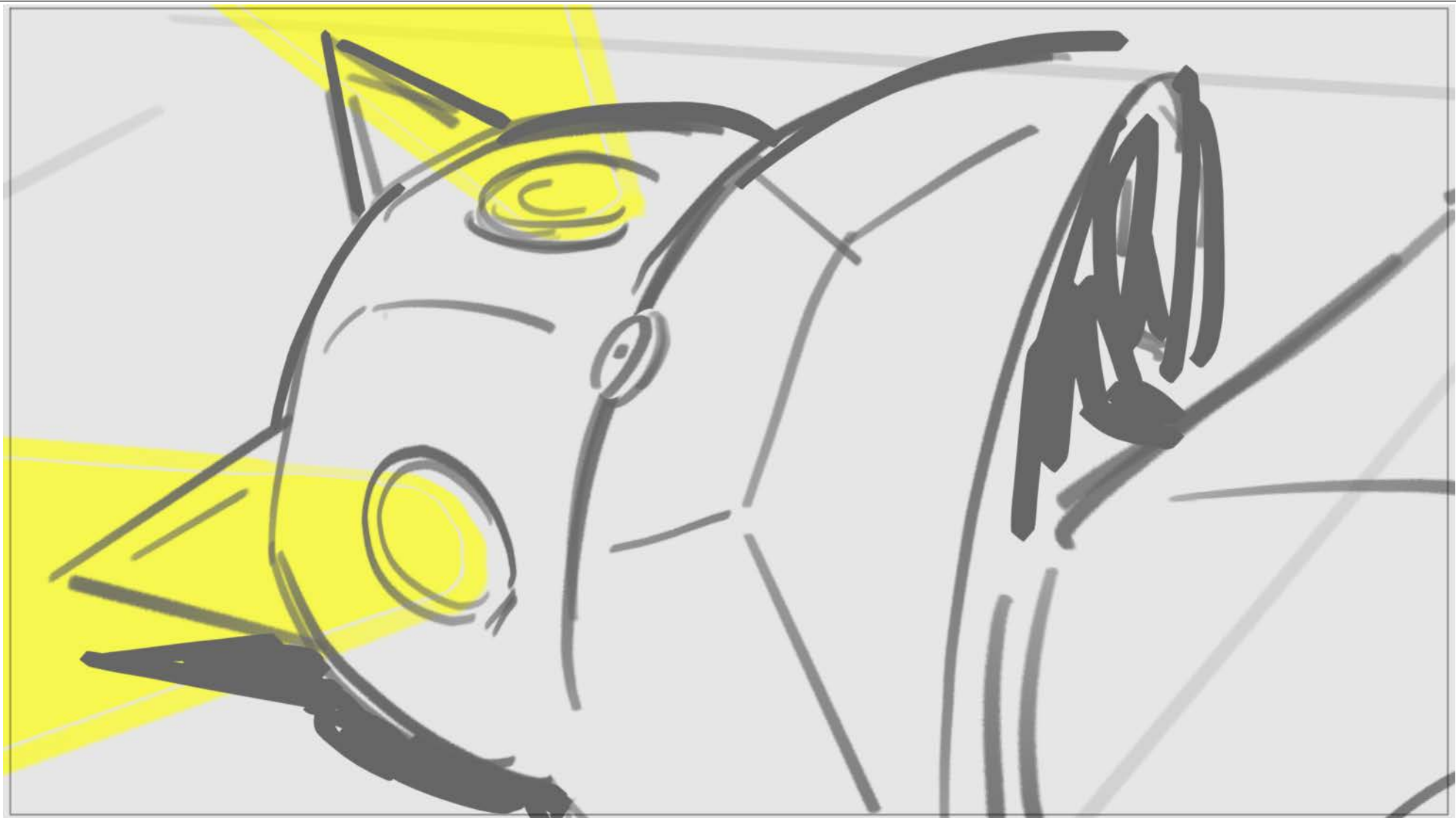

Seq	1		
Scene	Duration	Panel	Duration
29	01:15	1	00:14

Dia

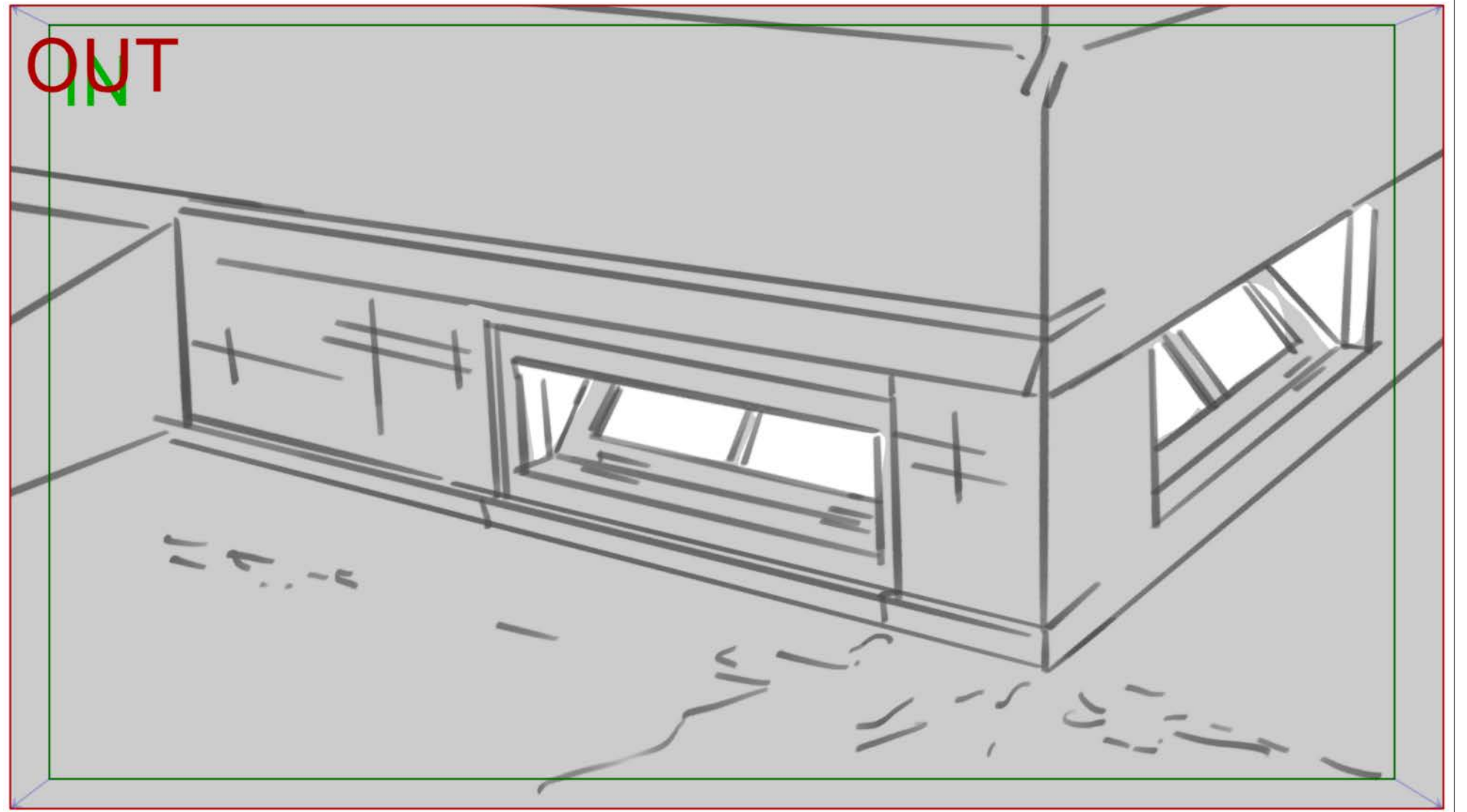

Seq	1		
Scene	Duration	Panel	Duration
29	01:15	2	01:01

Dia

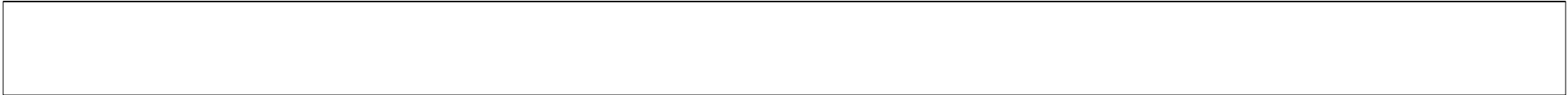
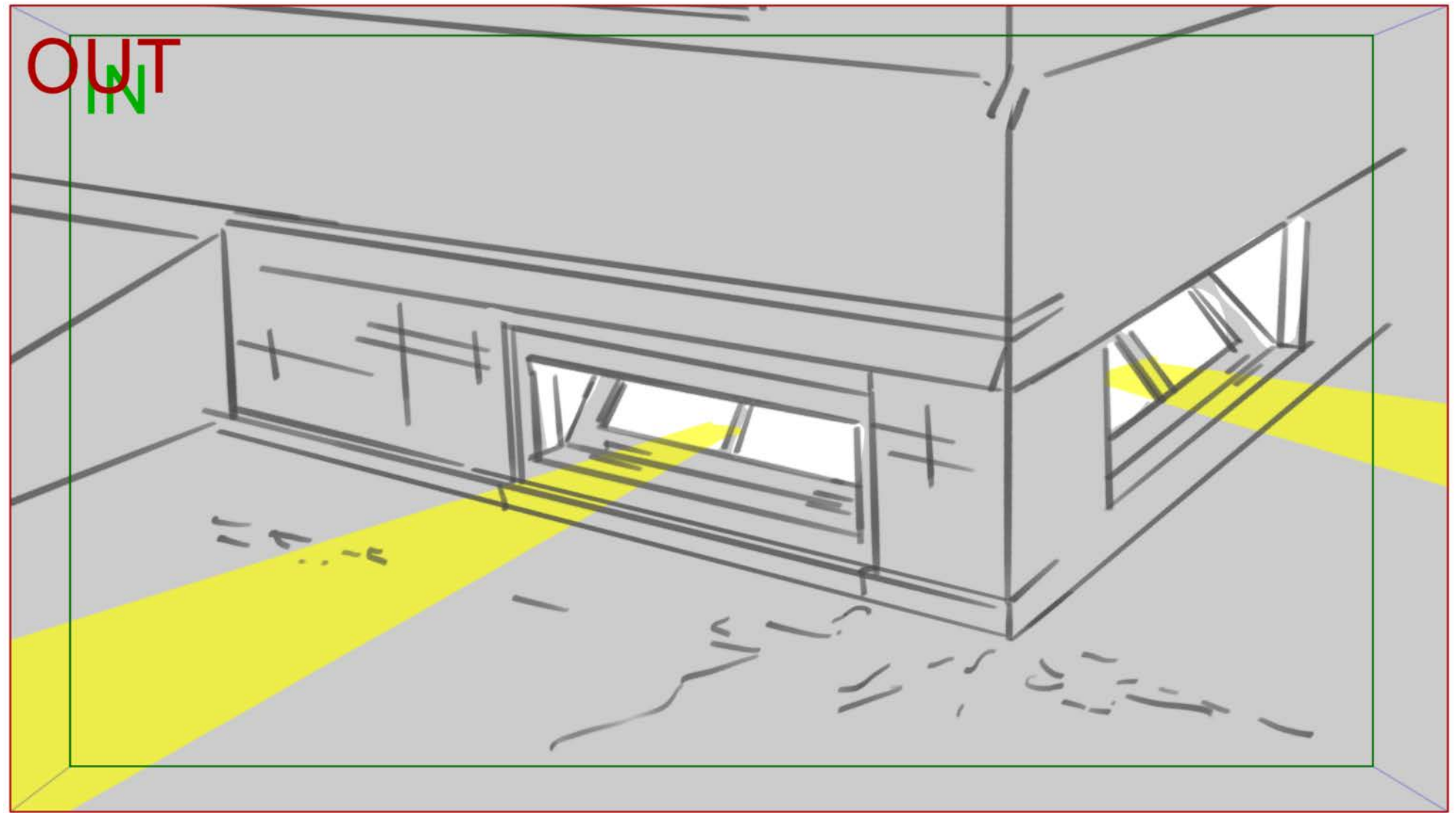

Seq	1		
Scene	Duration	Panel	Duration
30	01:13	1	01:13

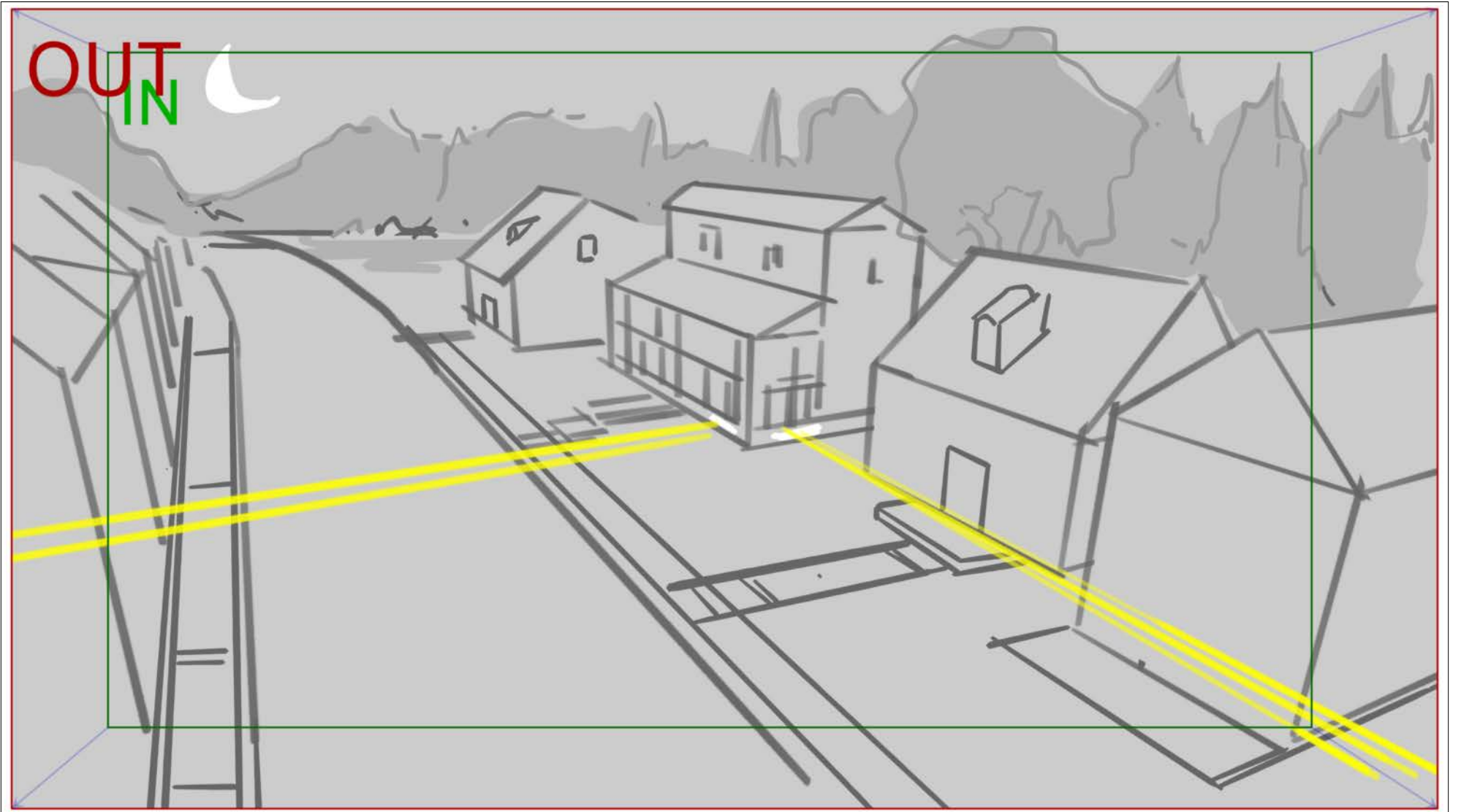

Seq	1		
Scene	Duration	Panel	Duration
31	01:16	1	01:16

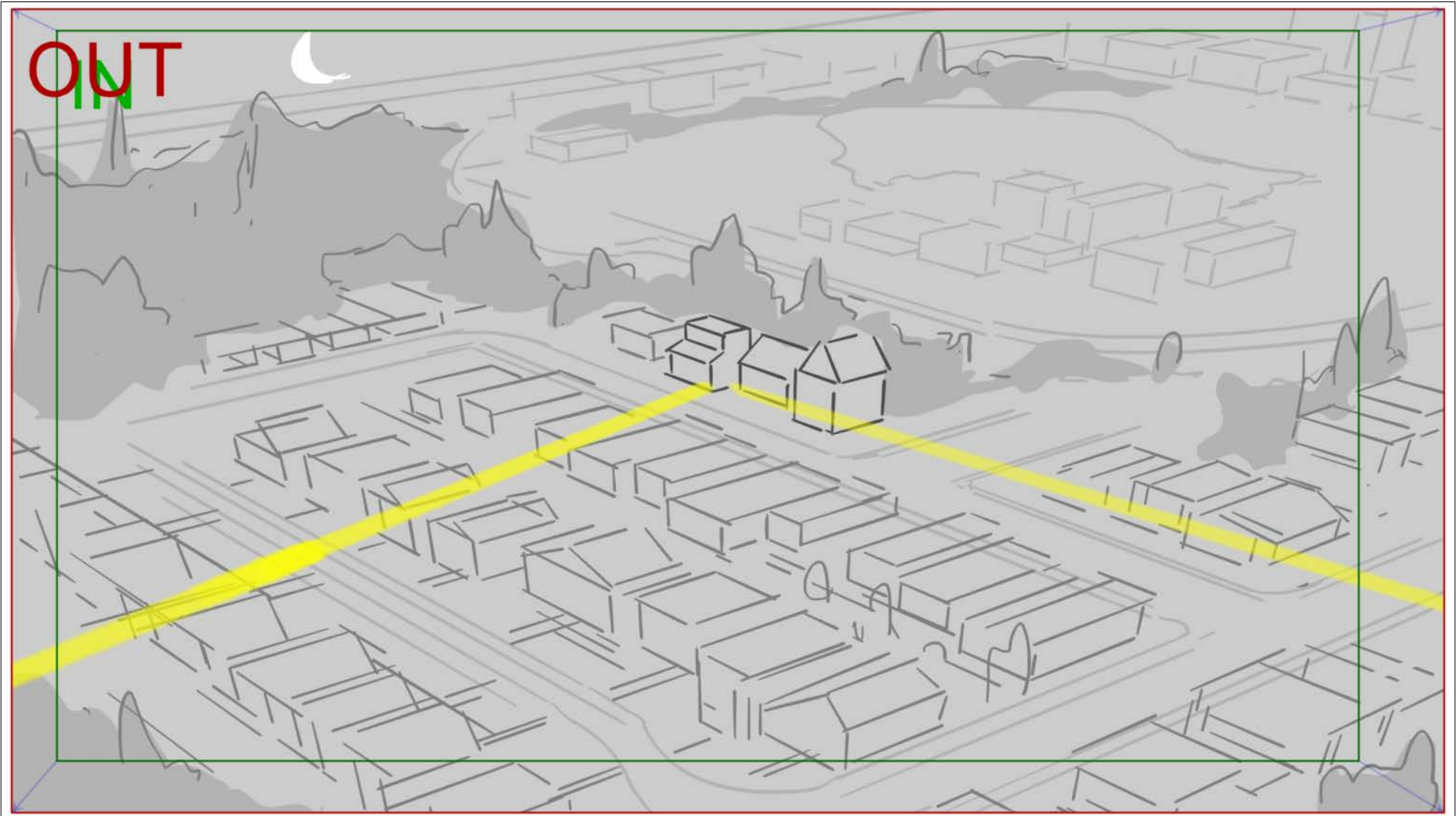

Seq	1		
Scene	Duration	Panel	Duration
32	02:01	1	00:12



Seq	1		
Scene	Duration	Panel	Duration
32	02:01	2	00:17

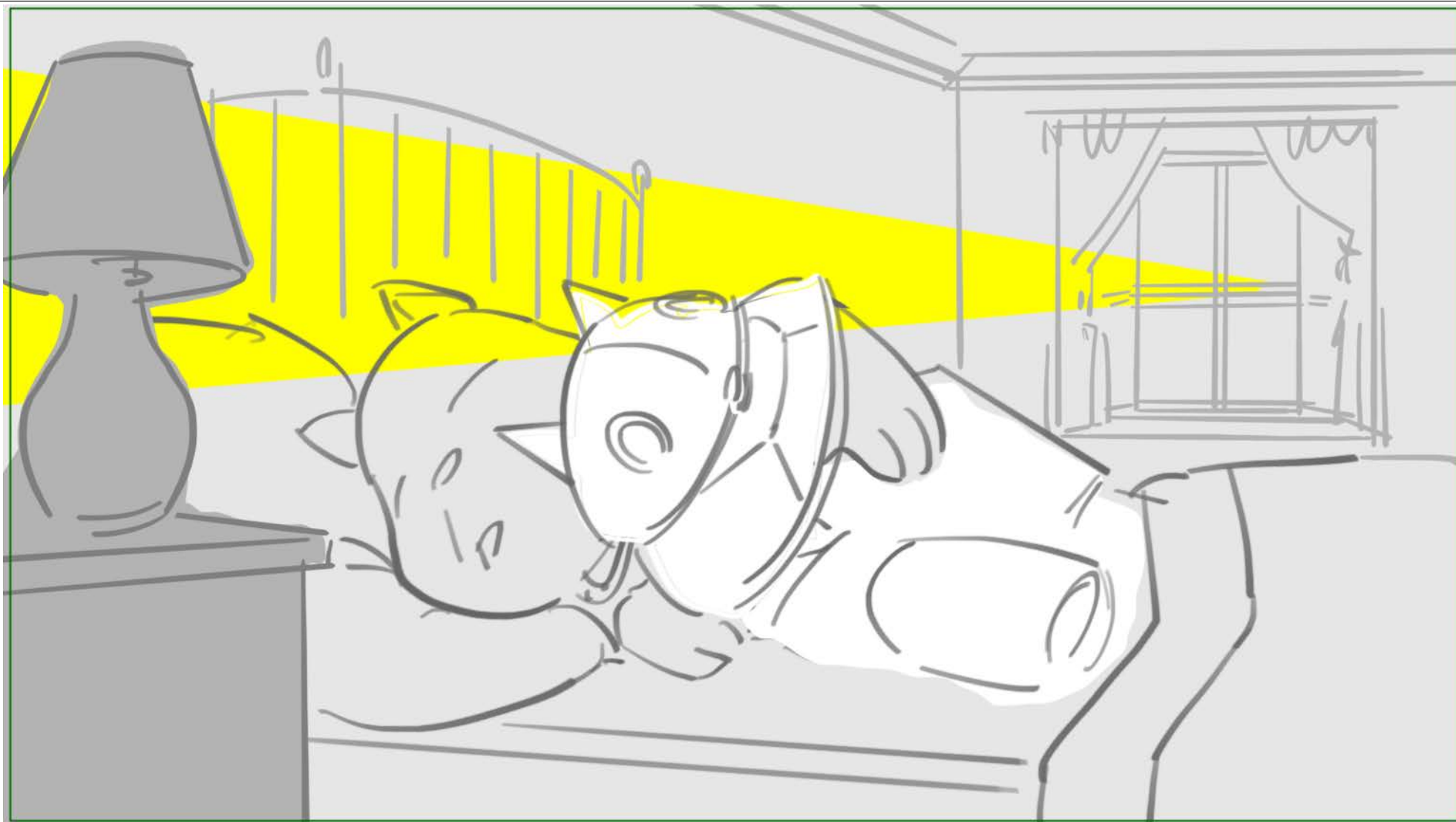

Seq	1		
Scene	Duration	Panel	Duration
32	02:01	3	00:20

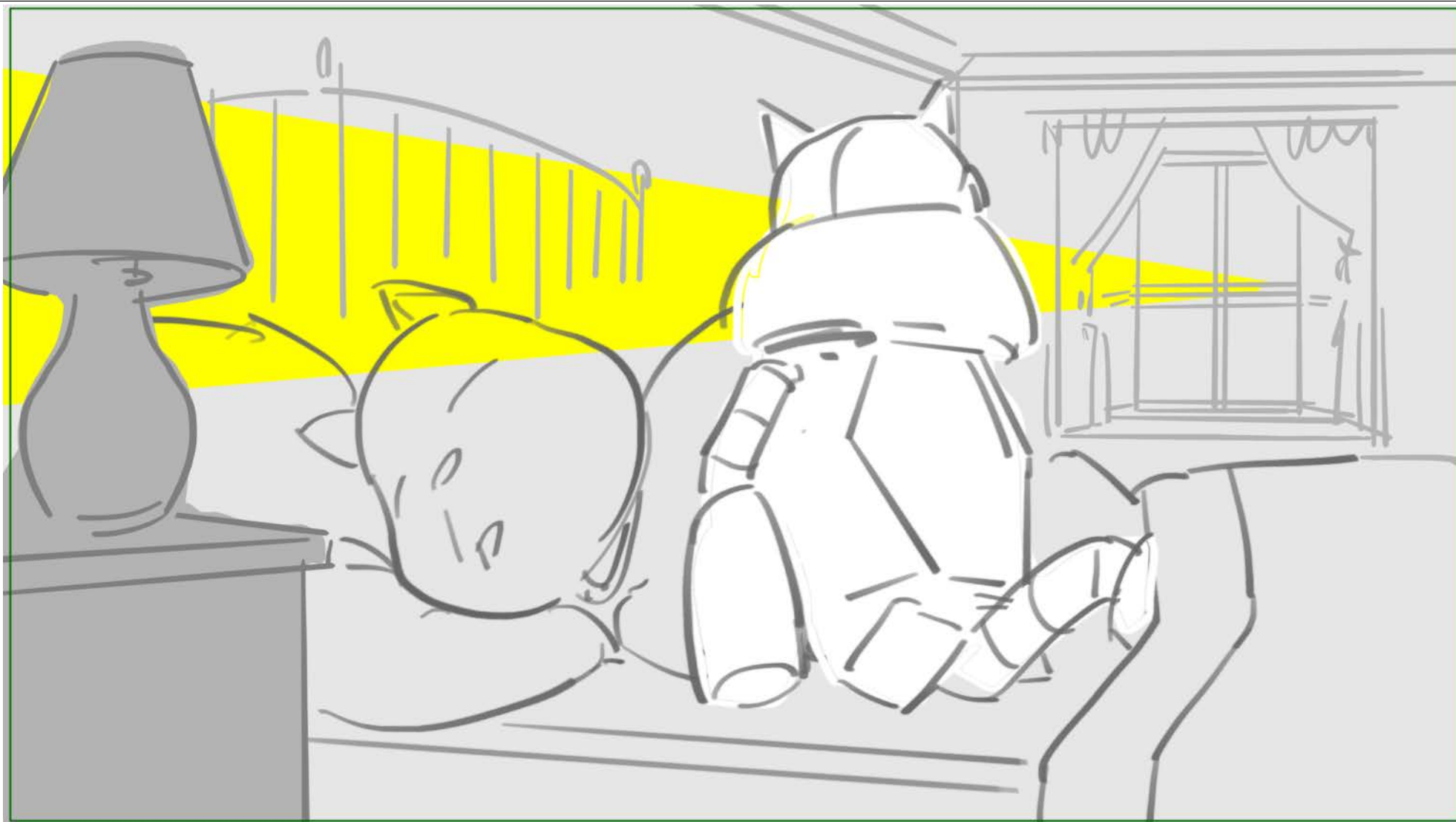

Seq	1		
Scene	Duration	Panel	Duration
33	02:06	1	00:10



Seq	1		
Scene	Duration	Panel	Duration
33	02:06	2	00:10



Seq	1		
Scene	Duration	Panel	Duration
33	02:06	3	00:10



Seq	1		
Scene	Duration	Panel	Duration
33	02:06	4	01:00



Seq	1		
Scene	Duration	Panel	Duration
34	01:07	1	01:07

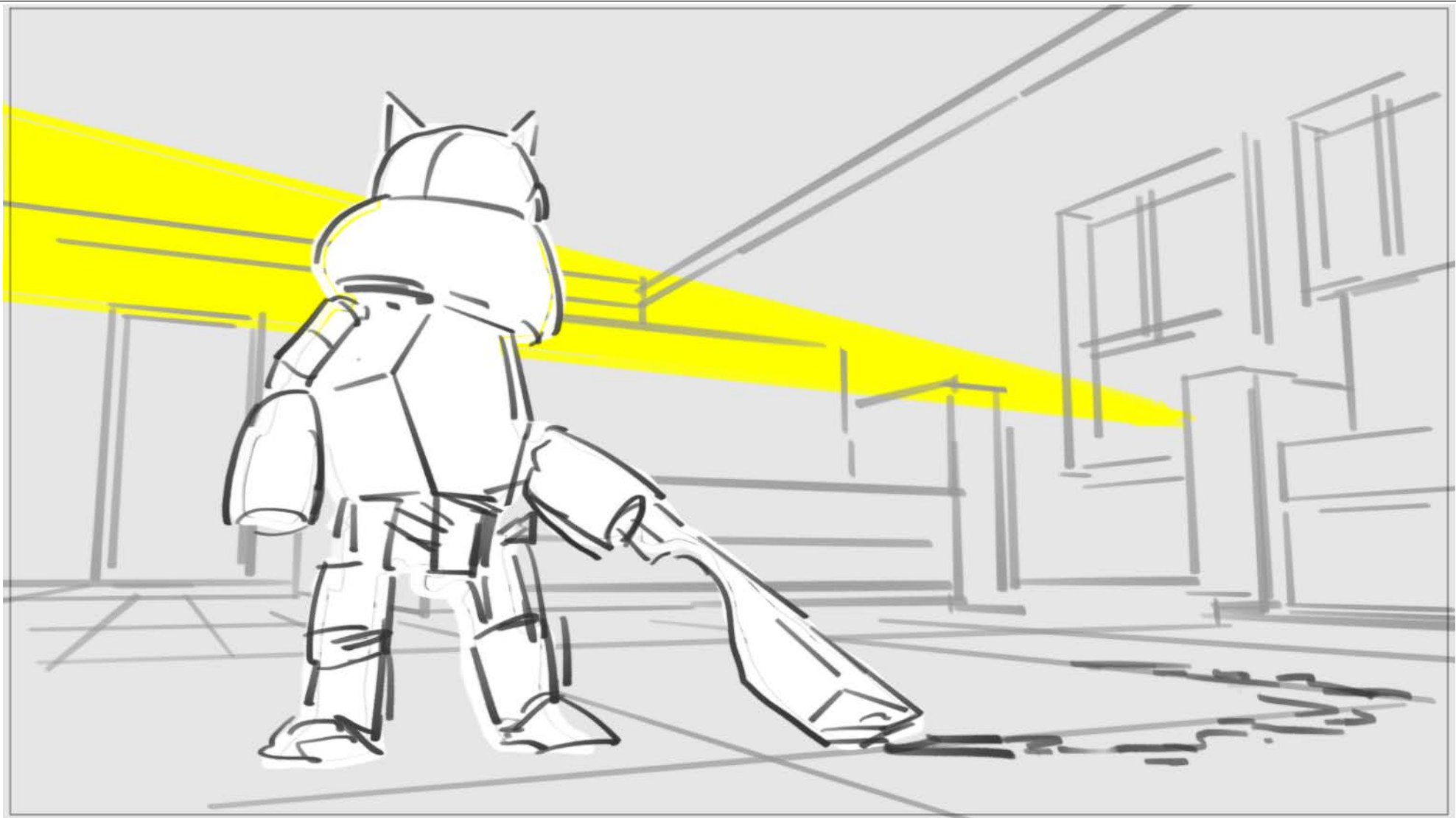

Seq	1		
Scene	Duration	Panel	Duration
35	02:00	1	00:17

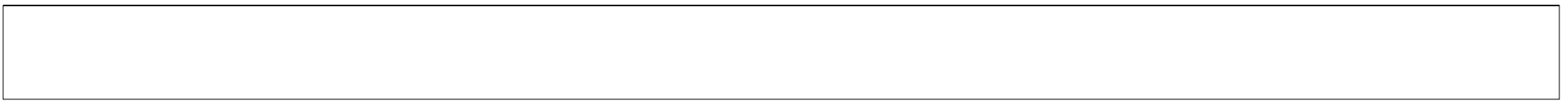
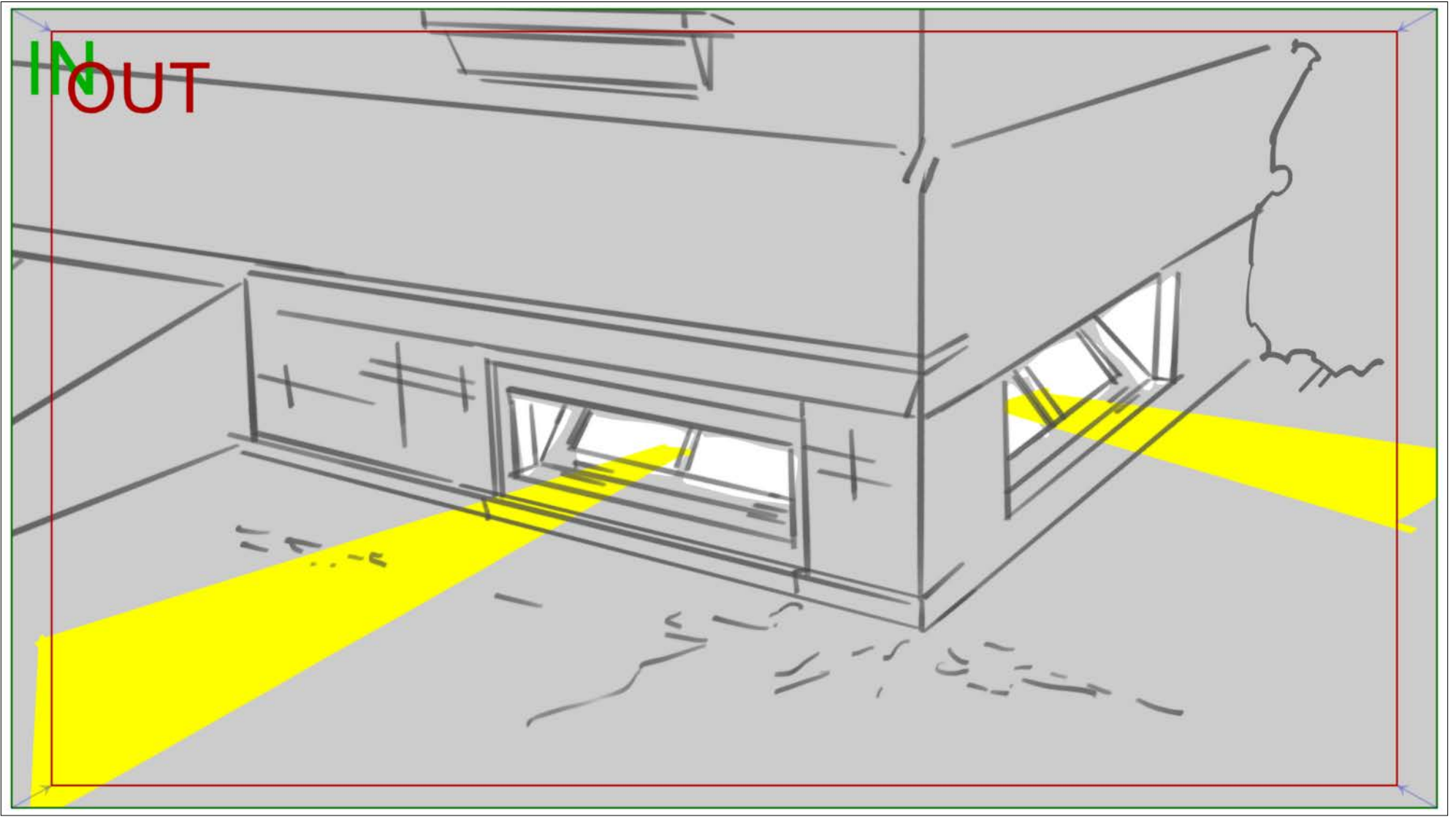

Seq	1		
Scene	Duration	Panel	Duration
35	02:00	2	01:07

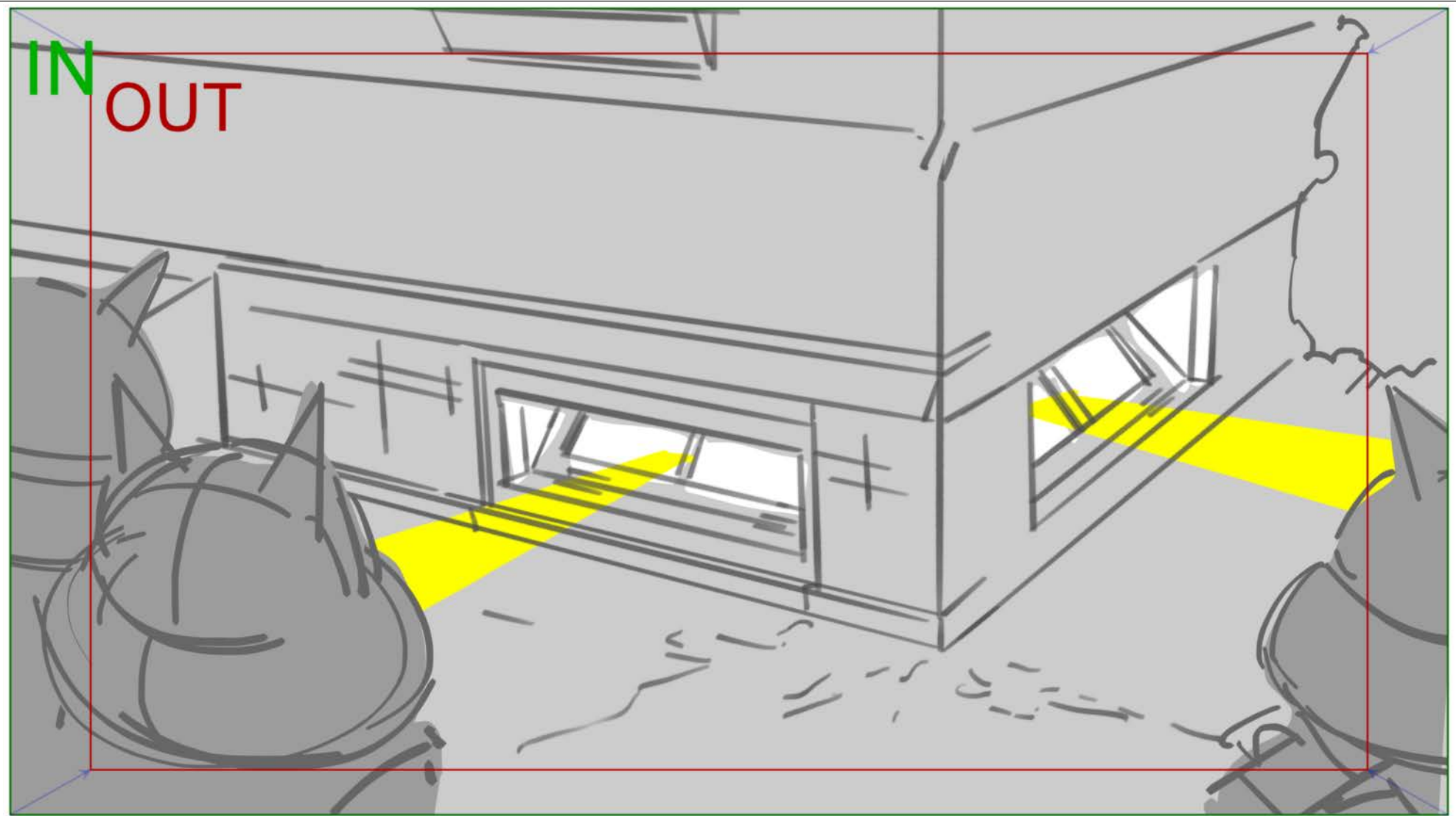

Seq	1		
Scene	Duration	Panel	Duration
36	01:13	1	01:00

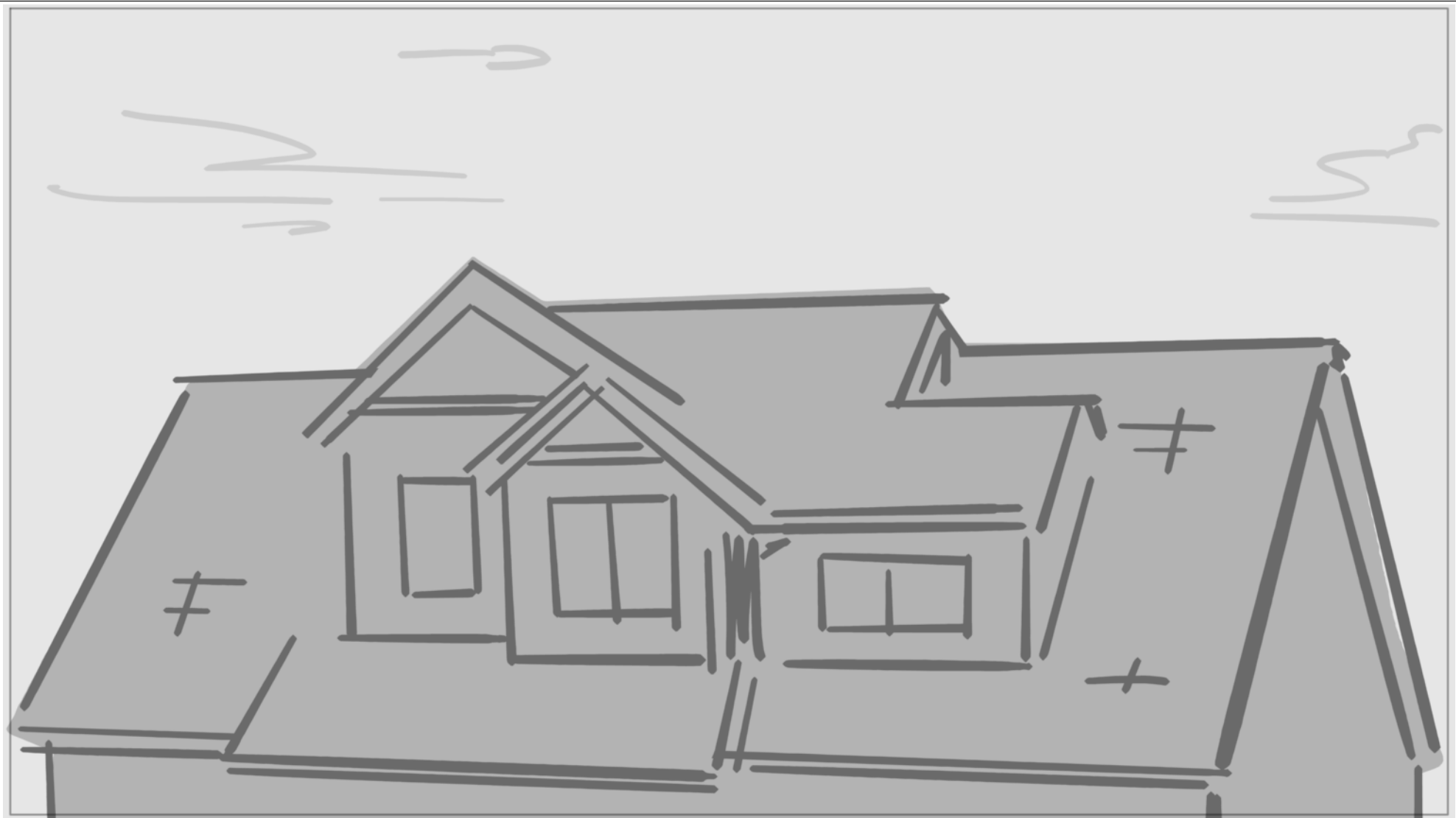

Seq	1		
Scene	Duration	Panel	Duration
36	01:13	2	00:13

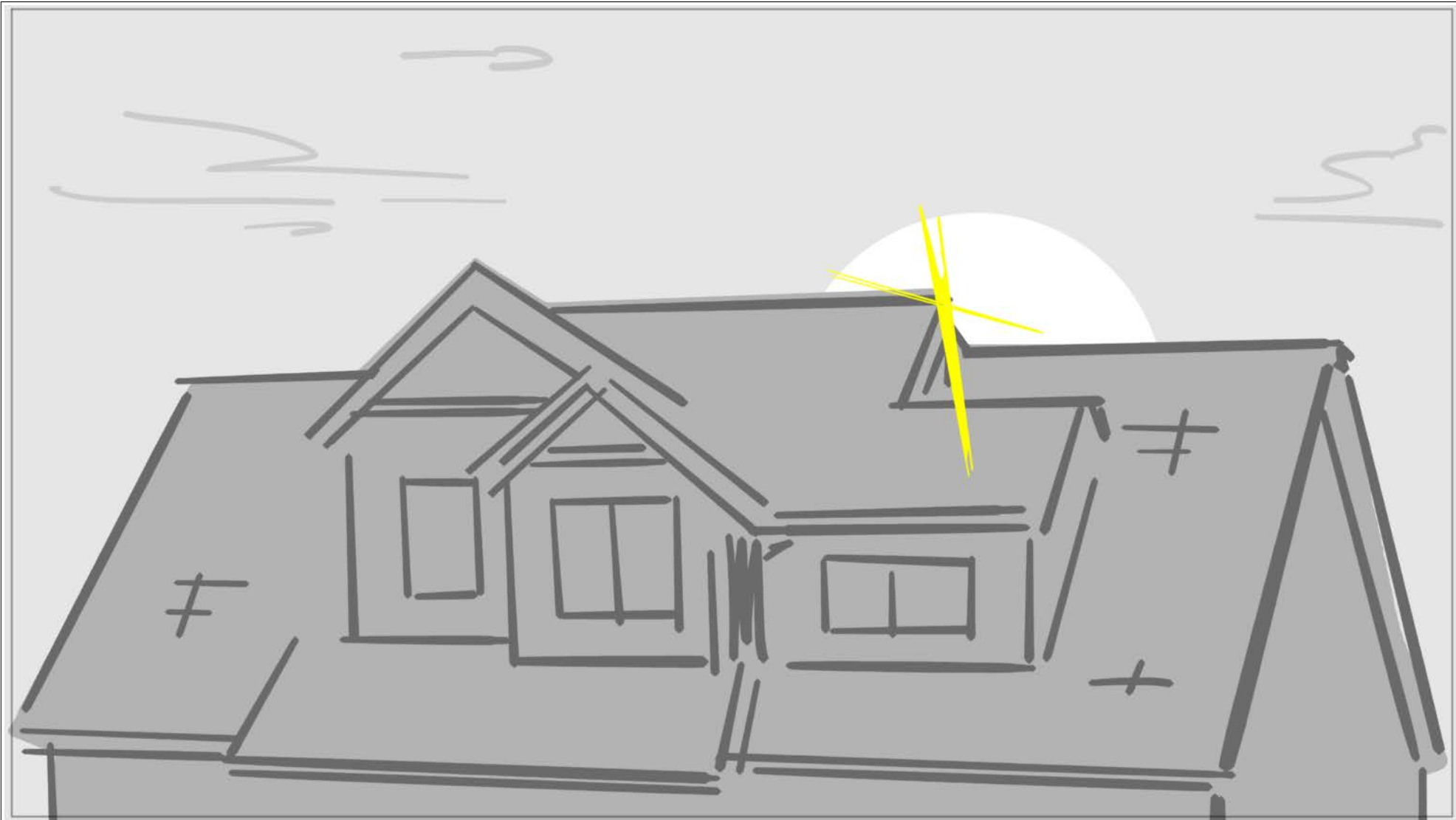

Seq	1		
Scene	Duration	Panel	Duration
37	00:14	1	00:14

Dia



Seq	1		
Scene	Duration	Panel	Duration
38	02:21	1	00:23

Dia



Seq	1		
Scene	Duration	Panel	Duration
38	02:21	2	00:04

Dia



Seq	1		
Scene	Duration	Panel	Duration
38	02:21	3	00:04

Dia



Seq	1		
Scene	Duration	Panel	Duration
38	02:21	4	00:04

Dia



Seq	1		
Scene	Duration	Panel	Duration
38	02:21	5	00:04

Dia



Seq	1		
Scene	Duration	Panel	Duration
38	02:21	6	00:08



Seq	1		
Scene	Duration	Panel	Duration
38	02:21	7	00:10

Dia



Seq	1		
Scene	Duration	Panel	Duration
38	02:21	8	00:05

Dia



Seq	1		
Scene	Duration	Panel	Duration
38	02:21	9	00:07

Dia



Seq	1		
Scene	Duration	Panel	Duration
39	00:19	1	00:19



Seq	1		
Scene	Duration	Panel	Duration
40	04:03	1	00:14



Seq	1		
Scene	Duration	Panel	Duration
40	04:03	2	00:15

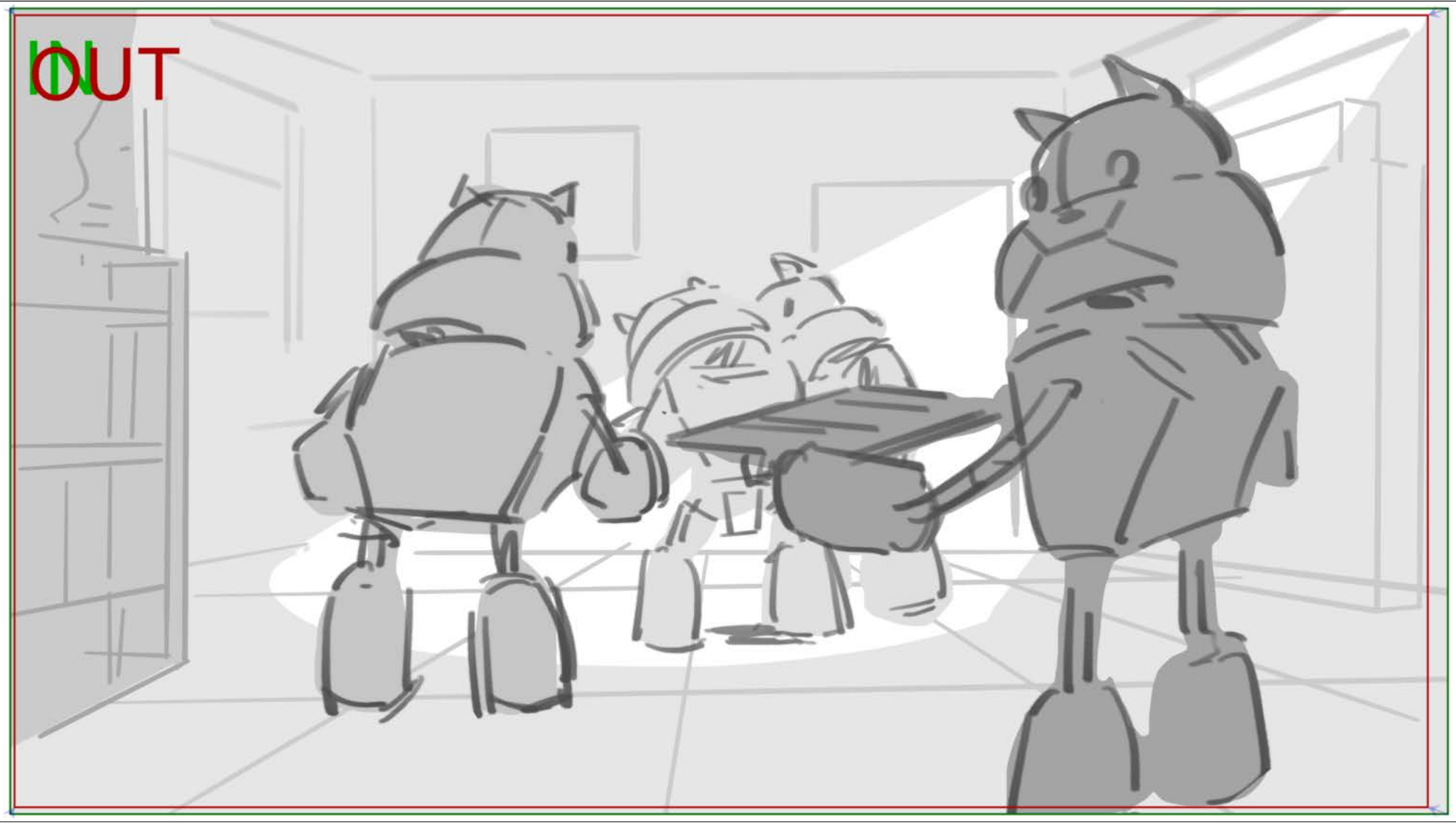

Seq	1		
Scene	Duration	Panel	Duration
40	04:03	3	00:10



Seq	1		
Scene	Duration	Panel	Duration
40	04:03	4	00:10

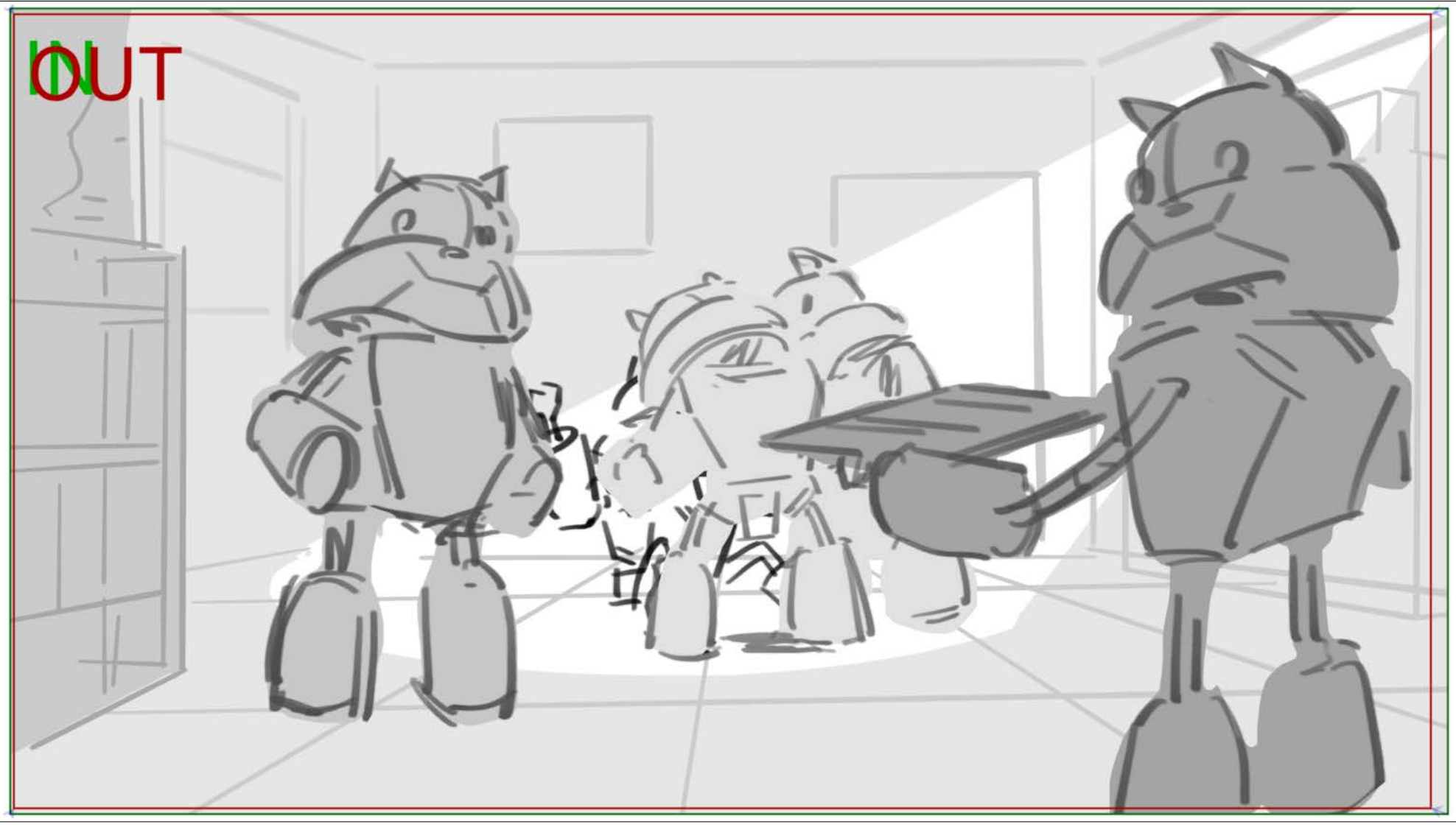

Seq	1		
Scene	Duration	Panel	Duration
40	04:03	5	00:19



Seq	1		
Scene	Duration	Panel	Duration
40	04:03	6	00:16



Seq	1		
Scene	Duration	Panel	Duration
40	04:03	7	00:15



Seq	1		
Scene	Duration	Panel	Duration
41	01:11	1	00:10



Seq	1		
Scene	Duration	Panel	Duration
41	01:11	2	00:15



Seq	1		
Scene	Duration	Panel	Duration
41	01:11	3	00:05

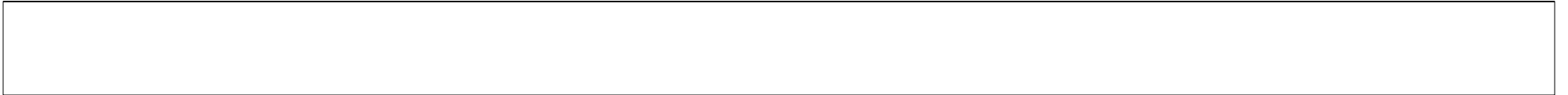
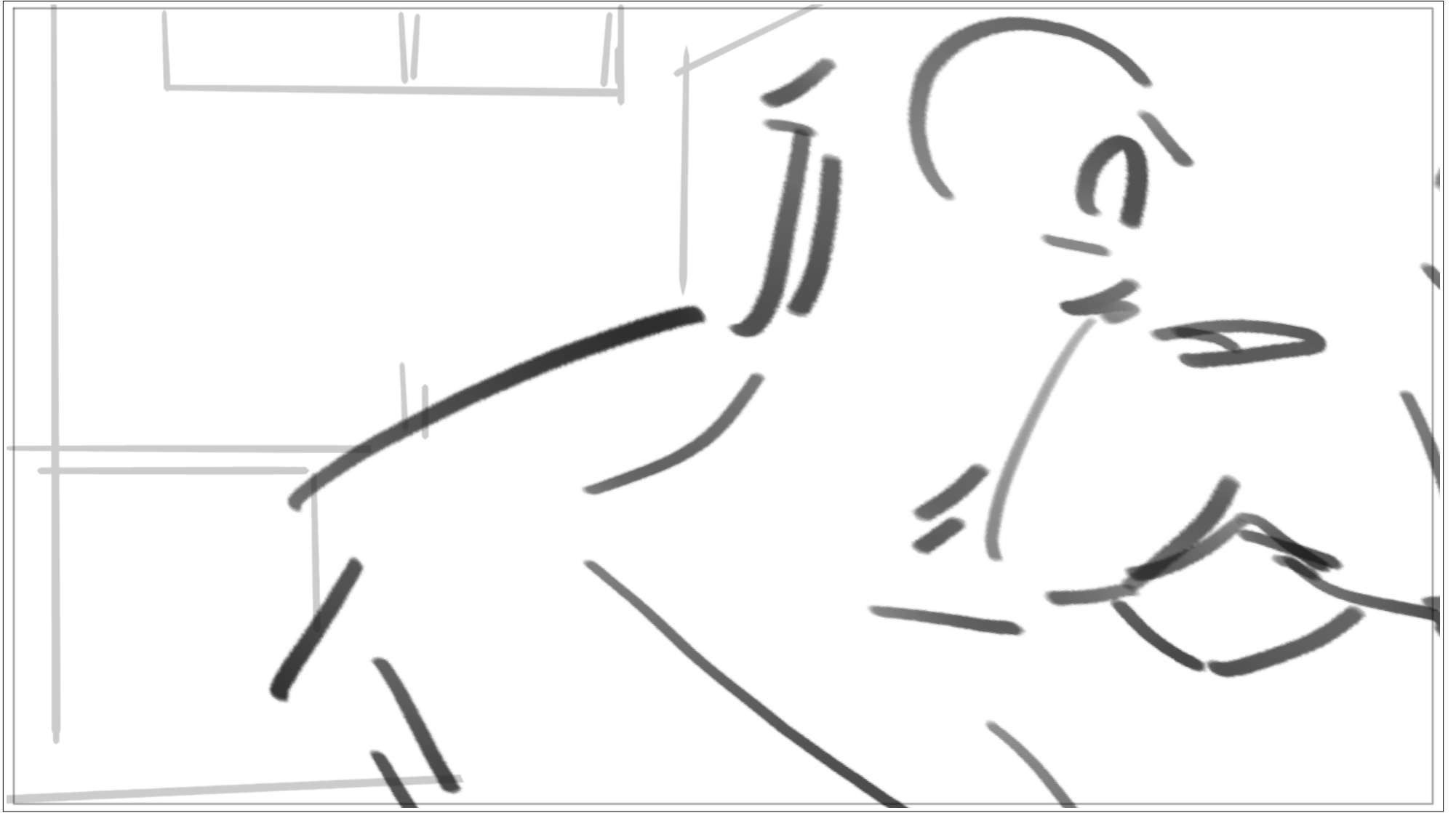

Seq	1		
Scene	Duration	Panel	Duration
41	01:11	4	00:05

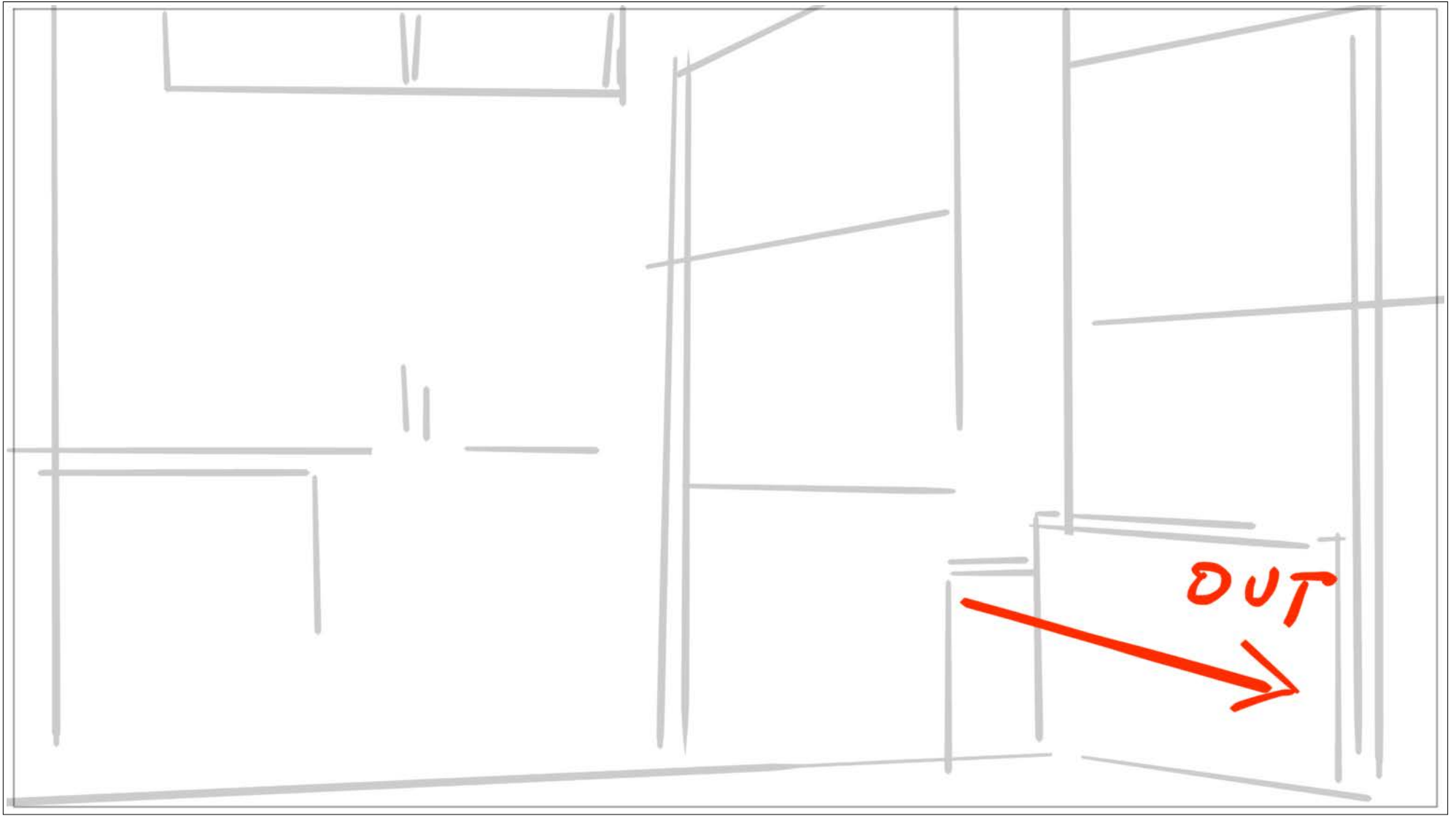

Seq	1		
Scene	Duration	Panel	Duration
42	02:11	1	00:12



Seq	1		
Scene	Duration	Panel	Duration
42	02:11	2	00:11

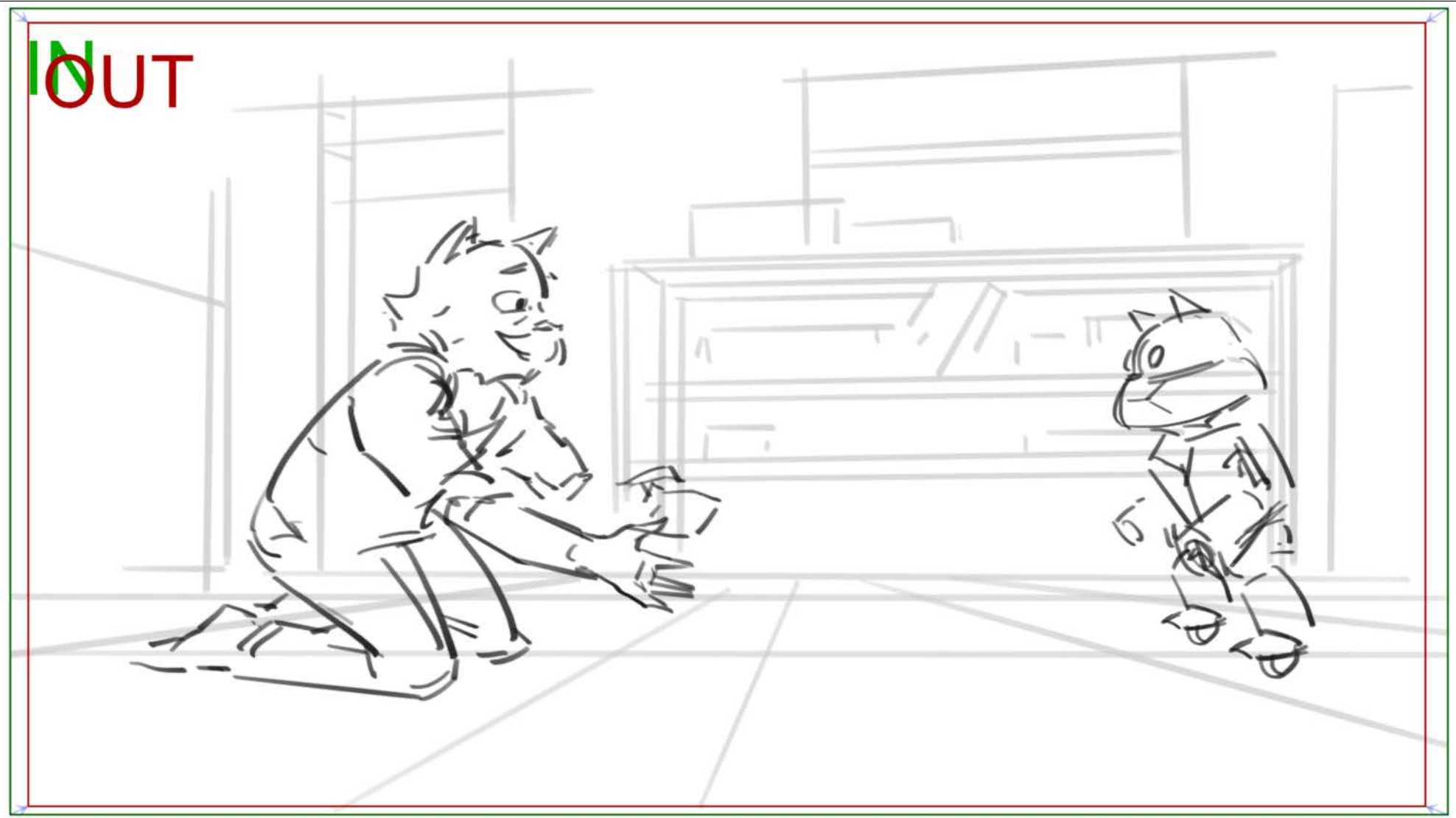

Seq	1		
Scene	Duration	Panel	Duration
42	02:11	3	00:18

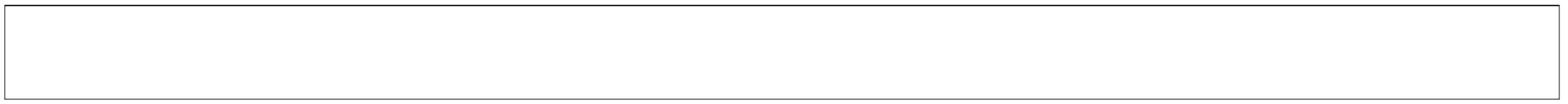
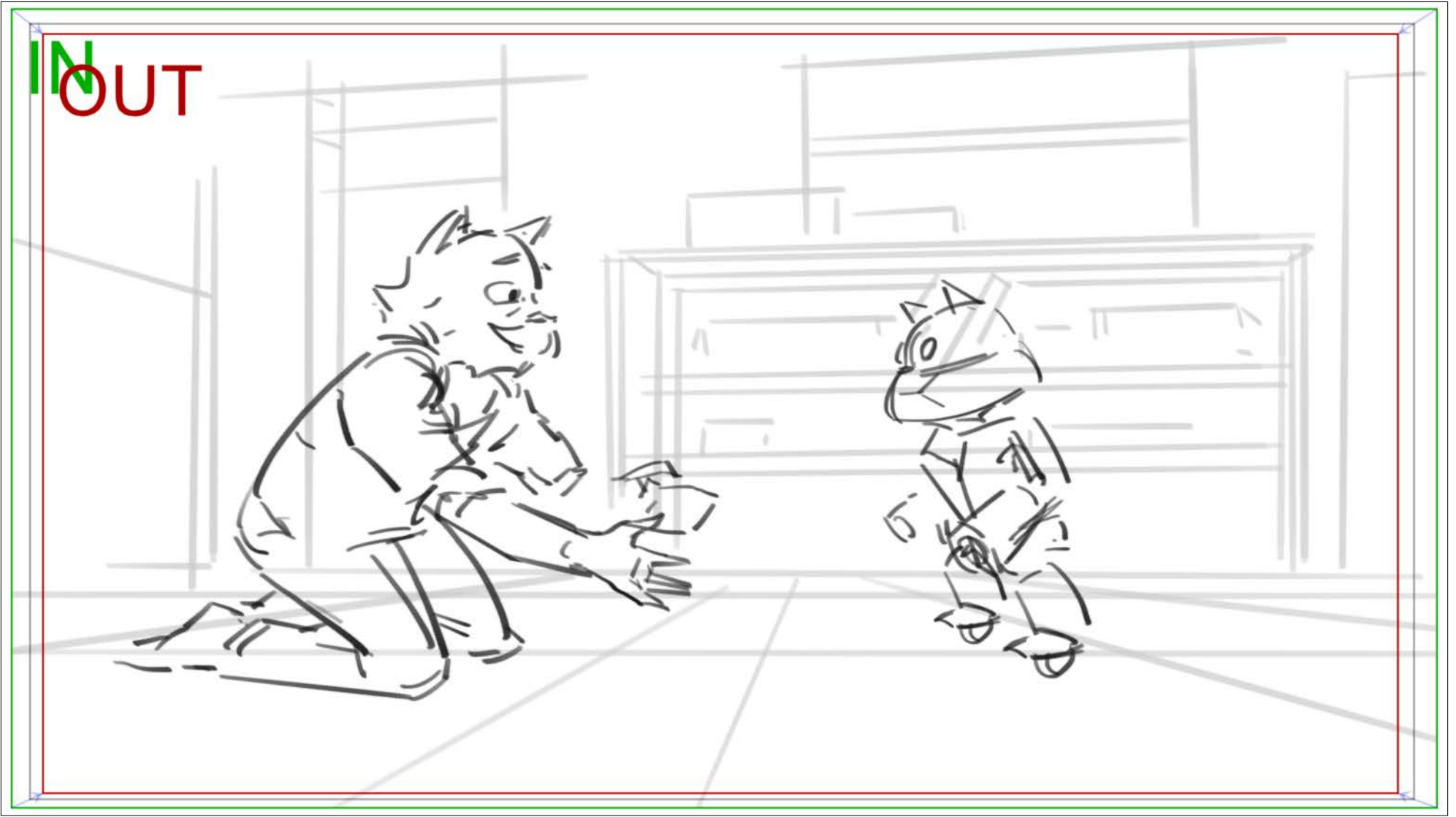

Seq	1		
Scene	Duration	Panel	Duration
42	02:11	3	00:18

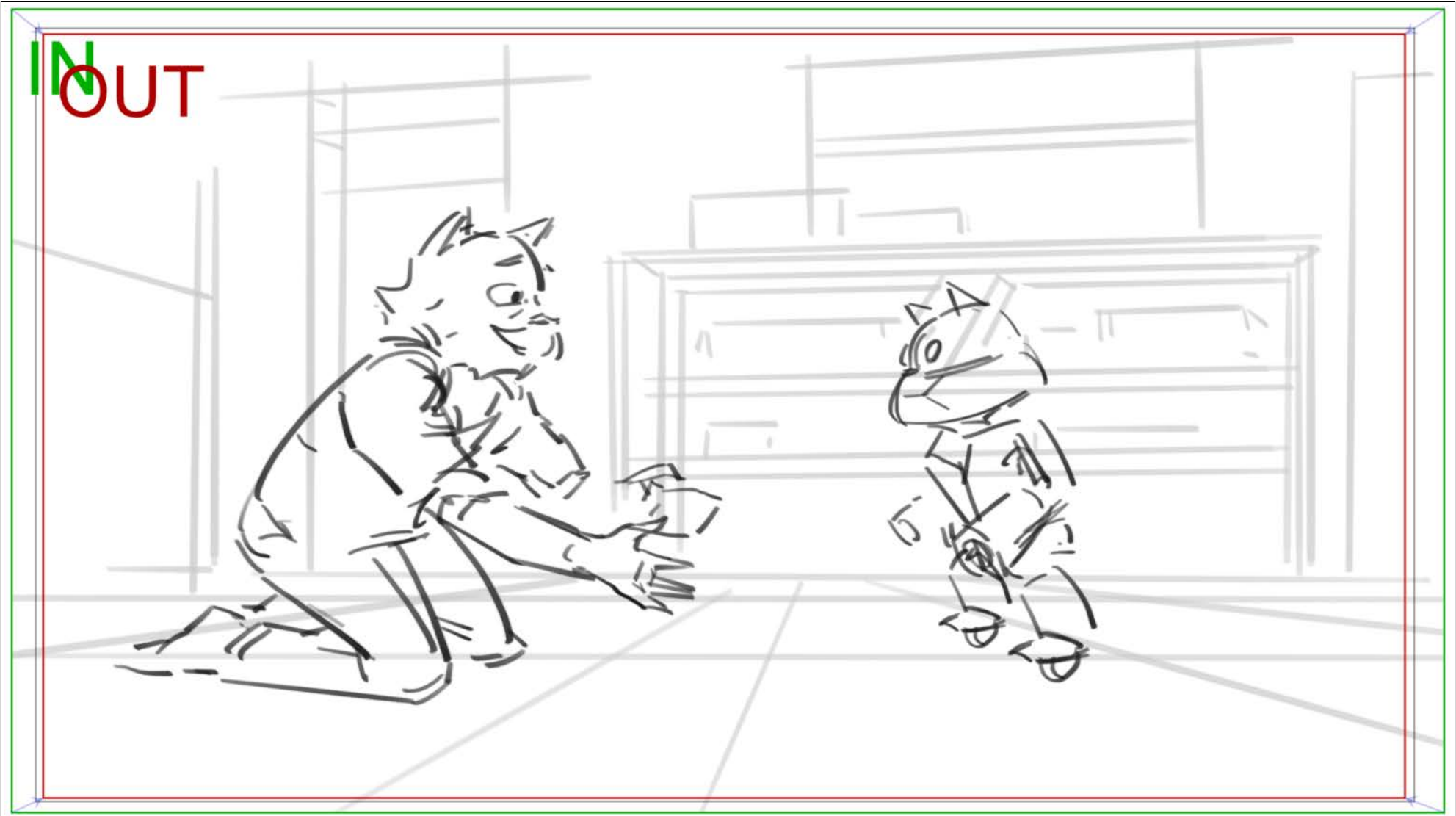

Seq	1		
Scene	Duration	Panel	Duration
42	02:11	3	00:18

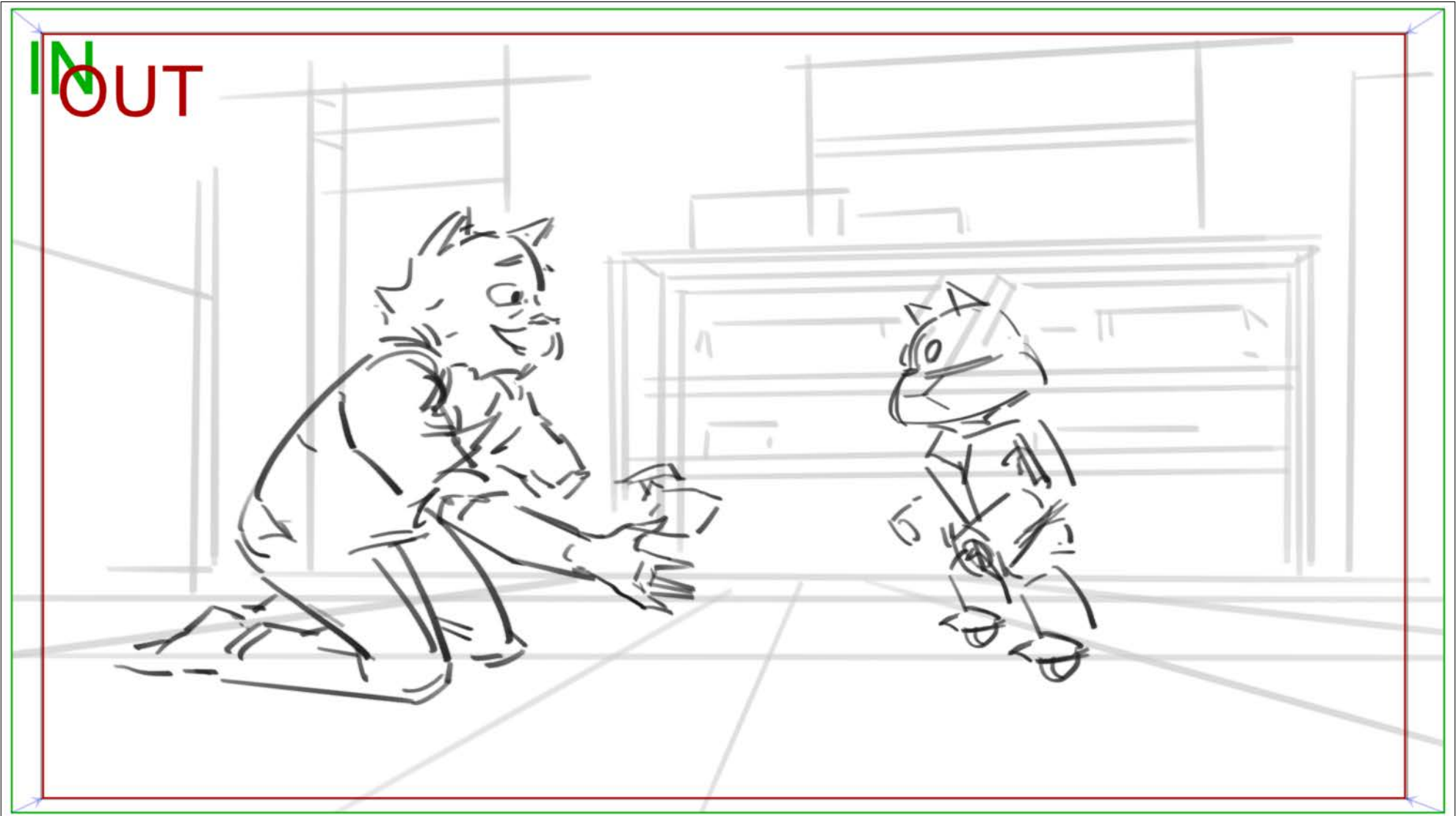

Seq	1		
Scene	Duration	Panel	Duration
42	02:11	4	00:18



Seq	1		
Scene	Duration	Panel	Duration
42	02:11	4	00:18



Seq	1		
Scene	Duration	Panel	Duration
42	02:11	4	00:18



Seq	1		
Scene	Duration	Panel	Duration
43	01:10	1	01:10

Dia

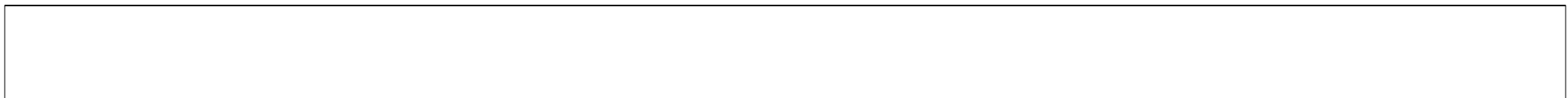
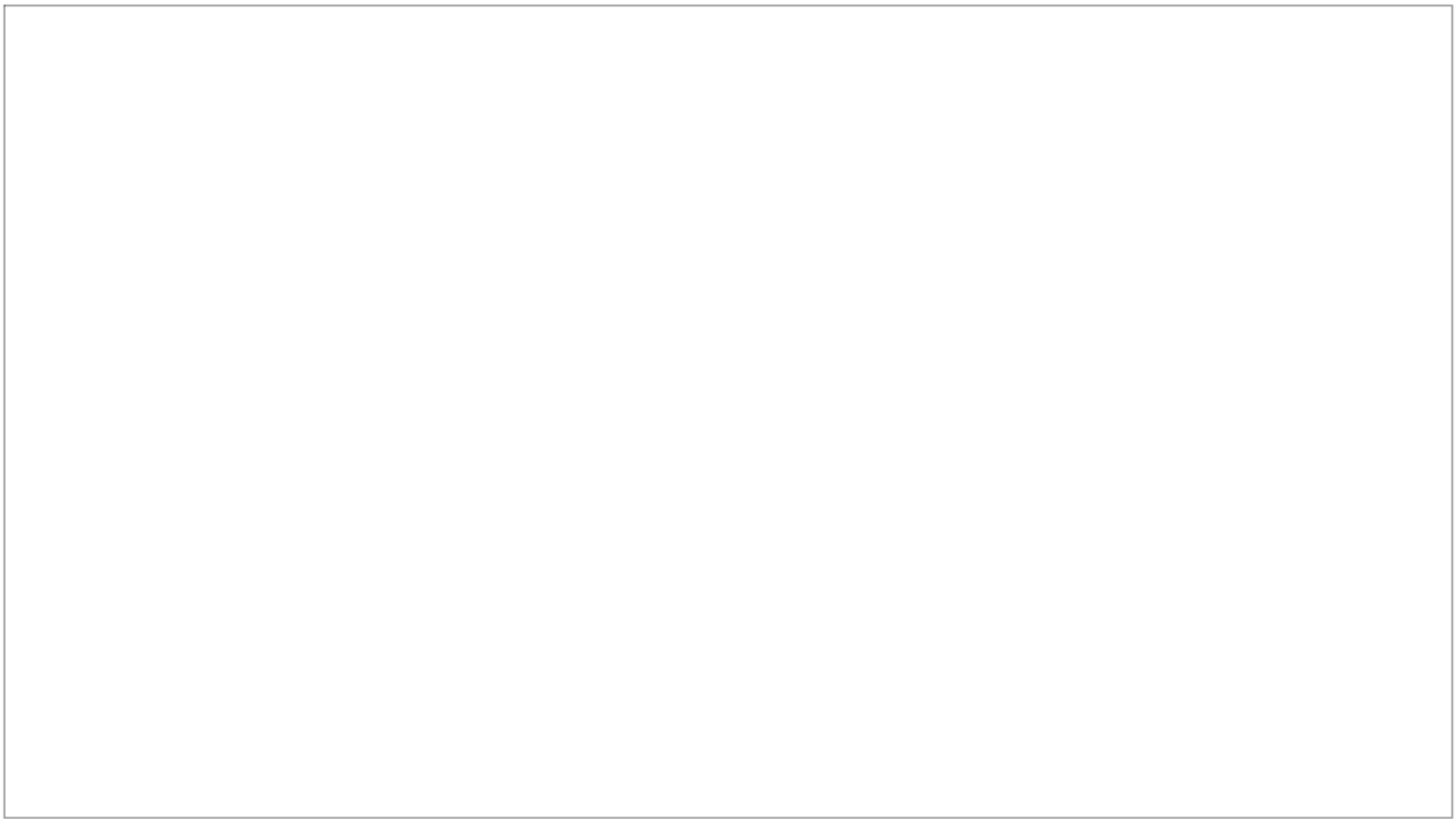

Seq	1		
Scene	Duration	Panel	Duration
43	01:10	1	01:10

Dia

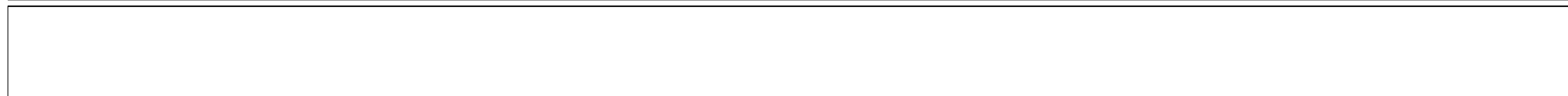
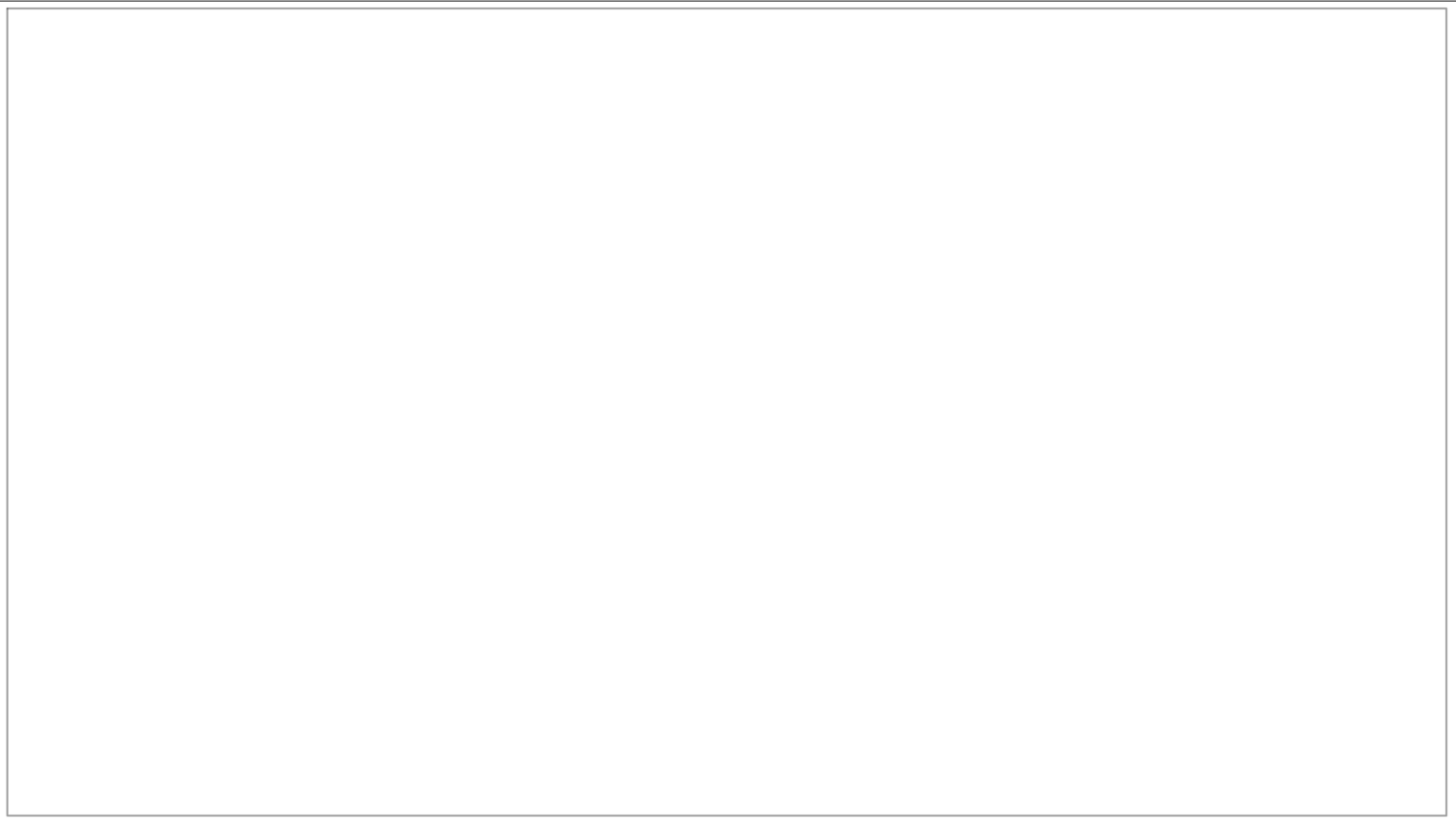

Seq	1		
Scene	Duration	Panel	Duration
44	07:12	1	00:23

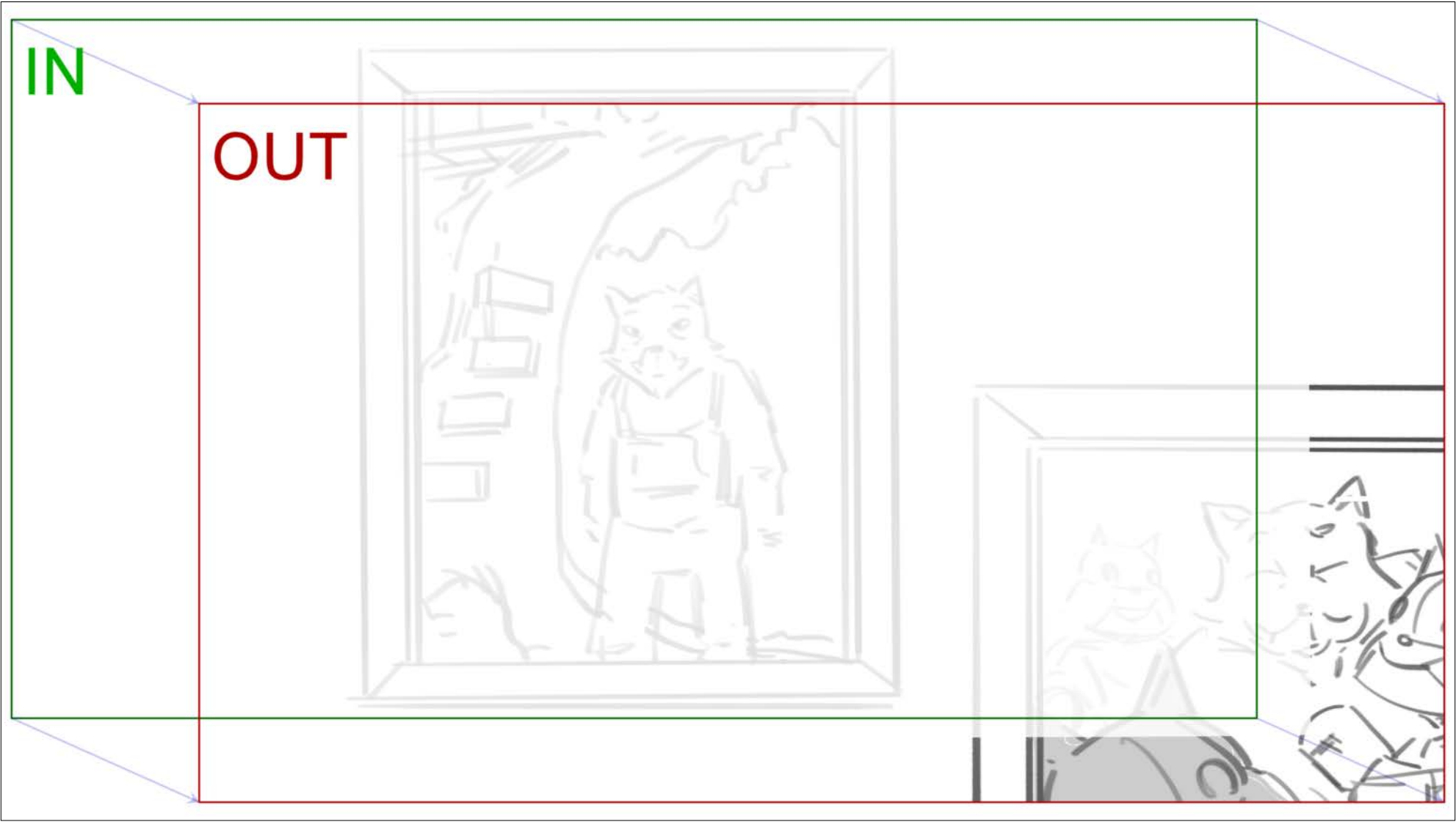

Seq	1		
Scene	Duration	Panel	Duration
44	07:12	2	00:10

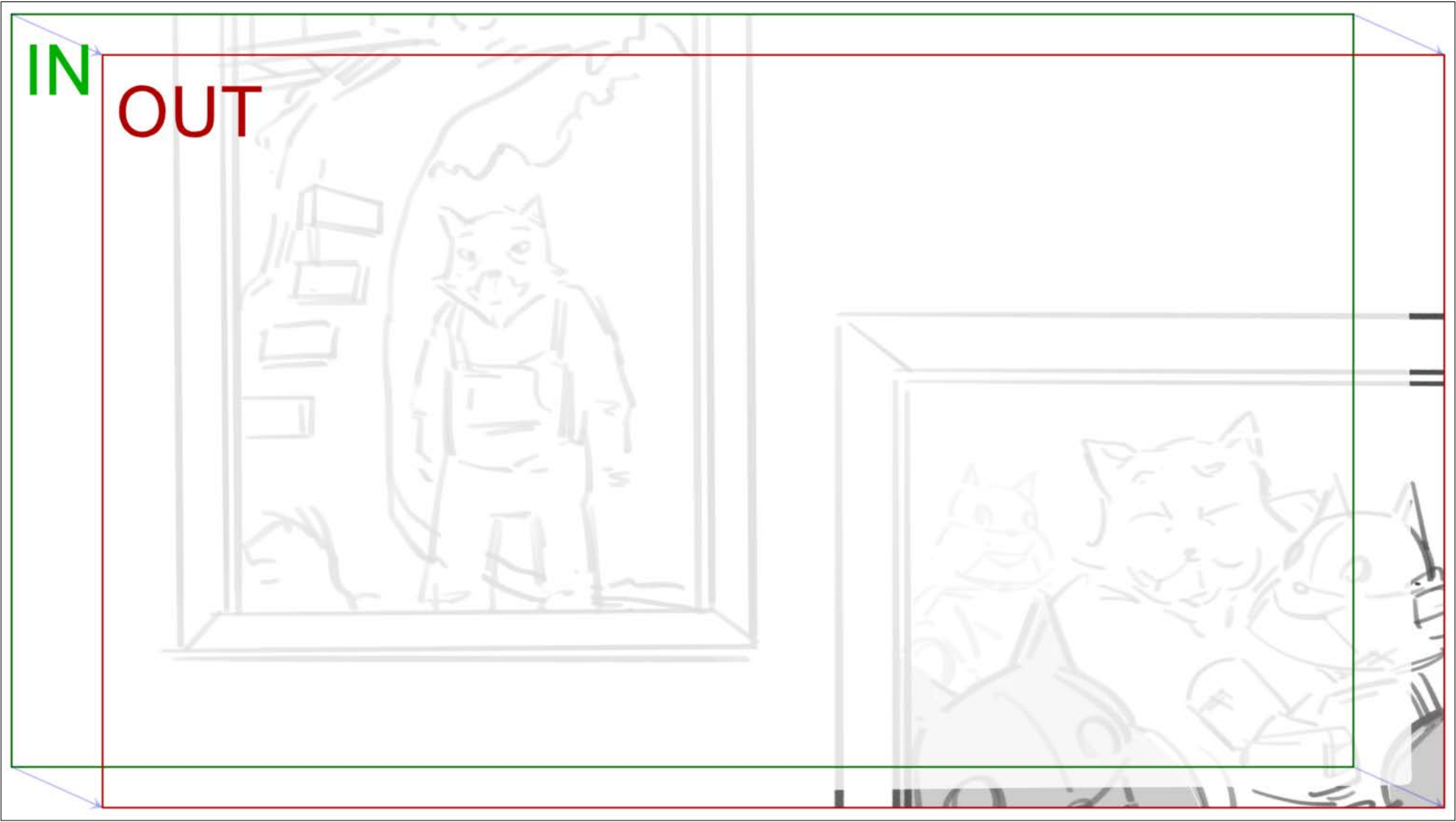

Seq	1		
Scene	Duration	Panel	Duration
44	07:12	3	01:01



Seq	1		
Scene	Duration	Panel	Duration
44	07:12	4	01:02

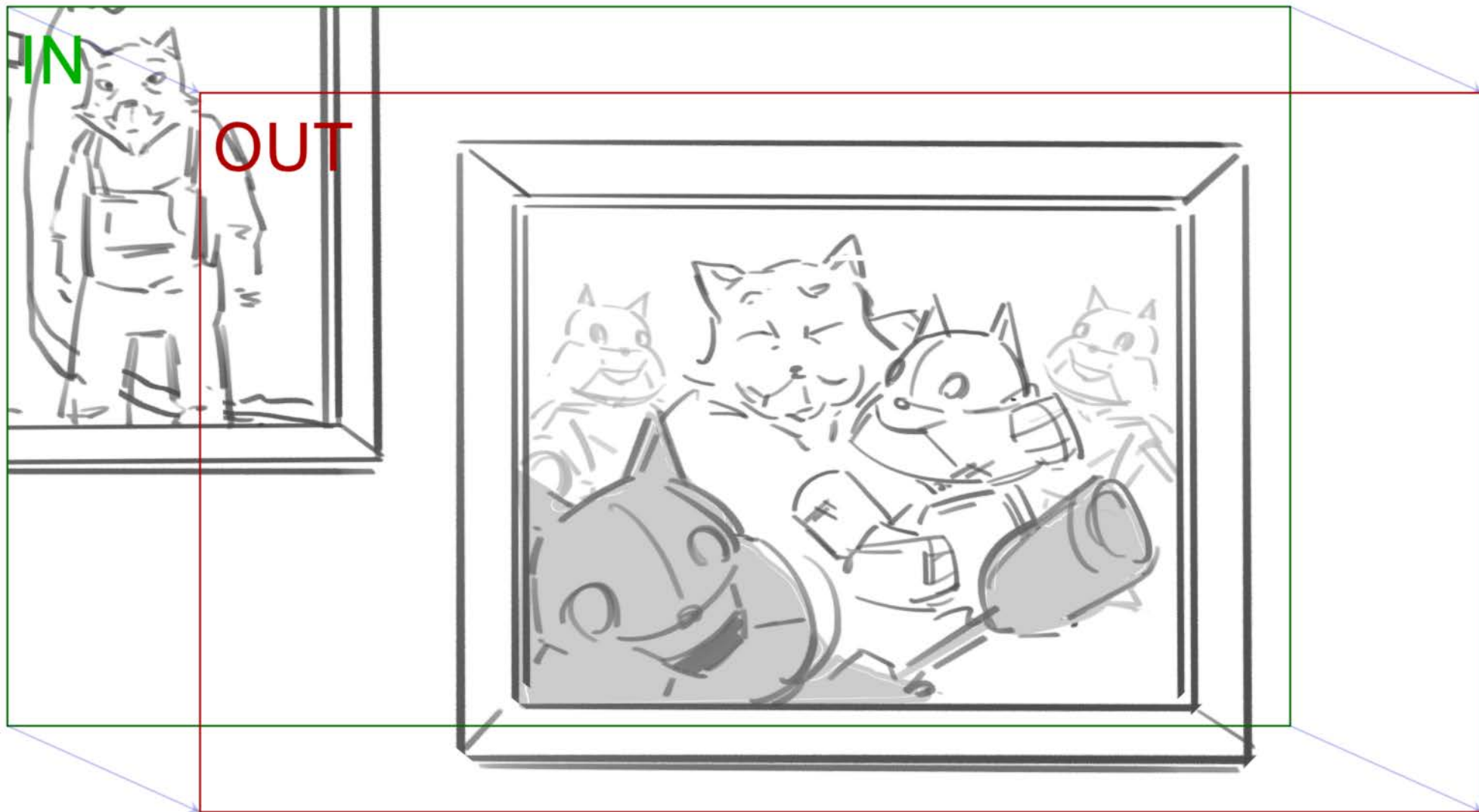

Seq	1		
Scene	Duration	Panel	Duration
44	07:12	5	01:08

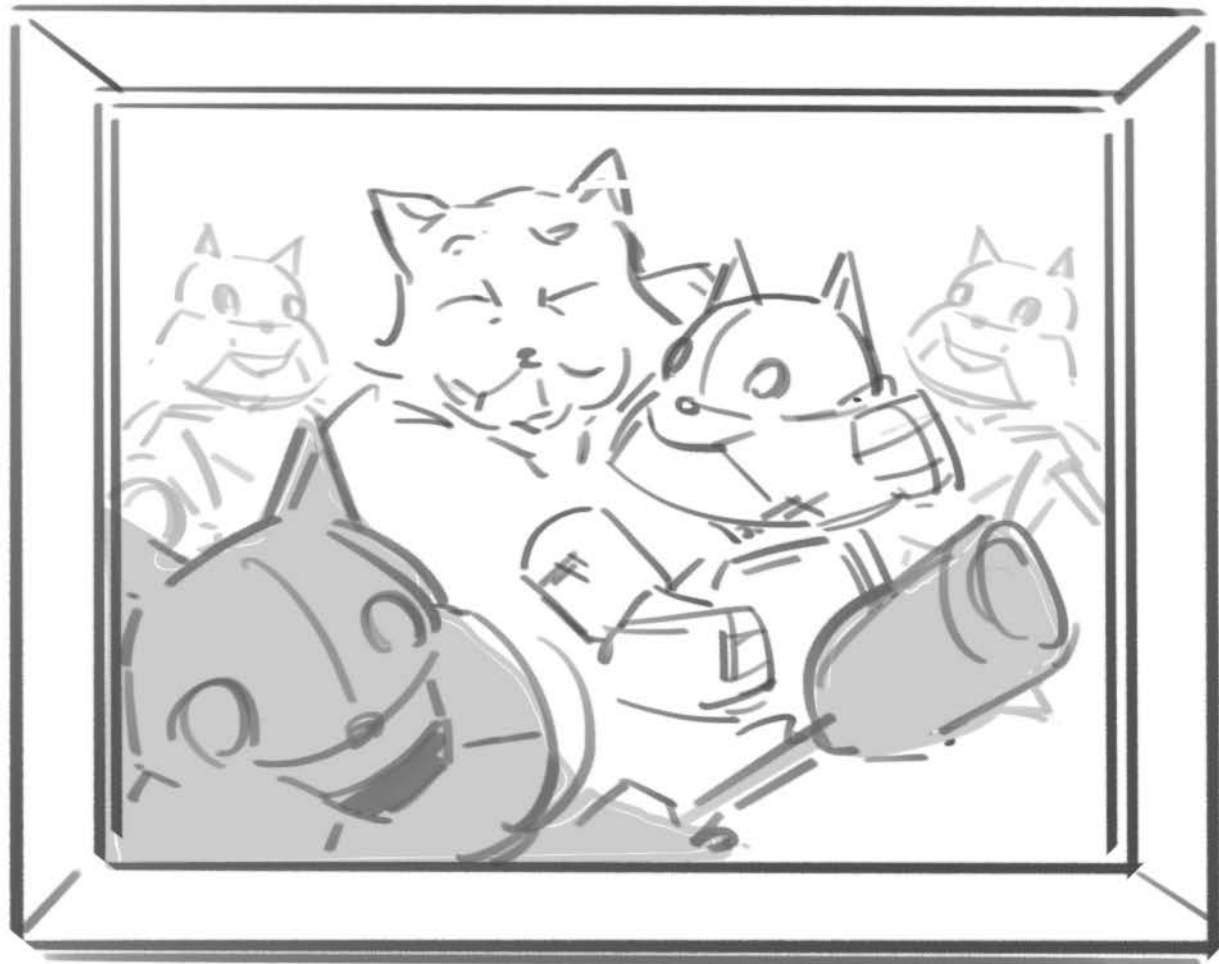
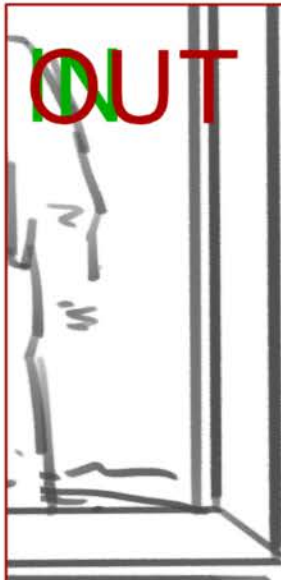

Seq	1		
Scene	Duration	Panel	Duration
44	07:12	6	01:08



Seq	1		
Scene	Duration	Panel	Duration
44	07:12	7	01:08

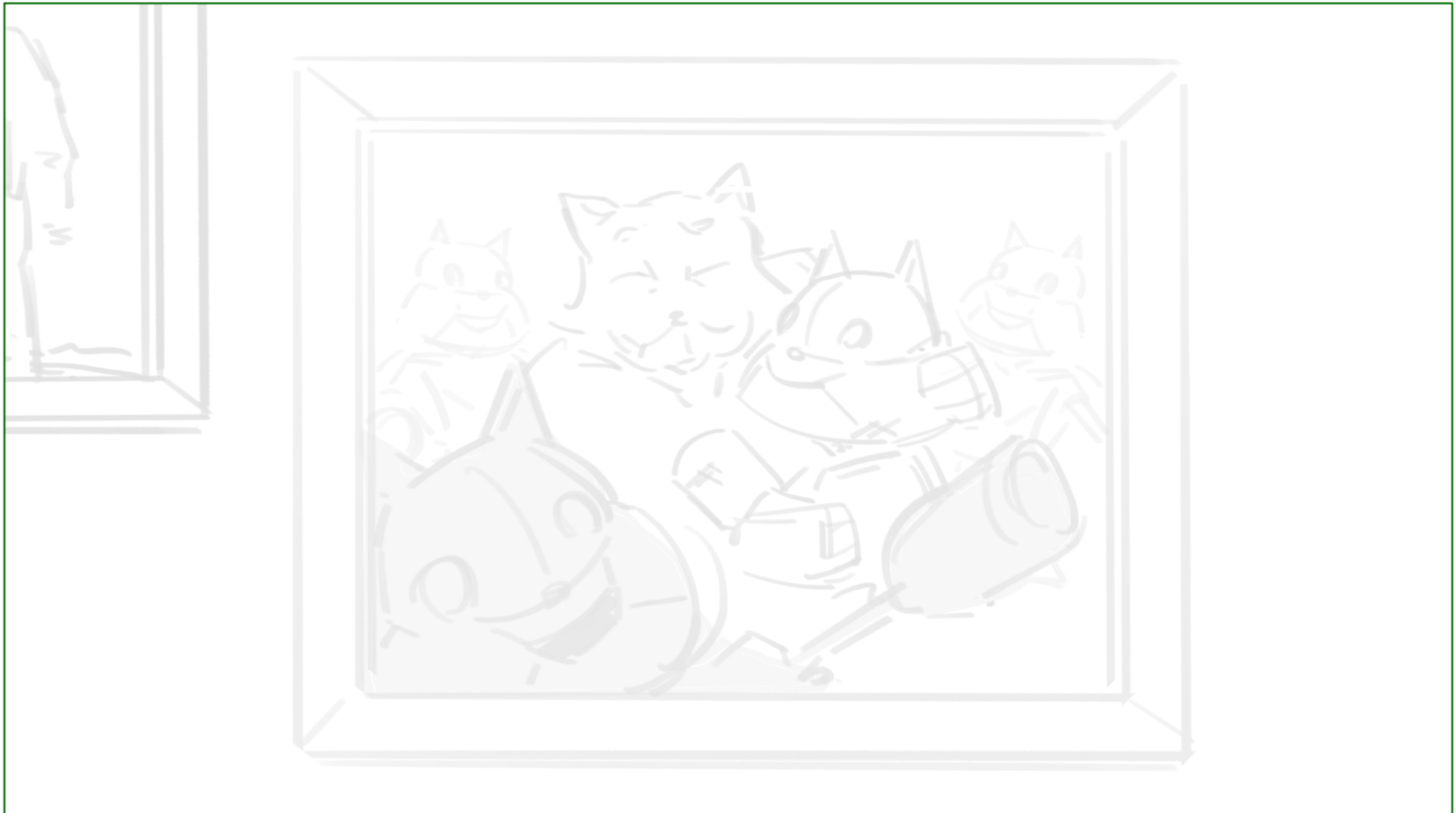

Seq	1		
Scene	Duration	Panel	Duration
45	02:16	1	02:16

Dia

